

TA-F7/TA-F7B

UK Model
AEP Model

TA-F7: silver panel
TA-F7B: black panel



TA-F7

INTEGRATED STEREO AMPLIFIER

SPECIFICATIONS

GENERAL

Power Requirements:	220V, 50/60 Hz (AEP model) 240V, 50/60 Hz (UK model)
Power Consumption:	400W (AEP model) 410W (UK model)
Dimensions:	Approx. 430 (w) x 170 (h) x 420 (d) mm 17 (w) x 6 ³ / ₄ (h) x 16 ⁵ / ₈ (d) inches Including projecting parts and controls
Weight:	Approx. 20.3 kg, 44 lb 12 oz (net) Approx. 24.3 kg, 53 lb 9 oz (with shipping carton)

Frequency Response: PHONO 1, 2 RIAA equalization curve ± 0.2 dB
TUNER }
AUX 1, 2 } 5-100,000 Hz ± 0 dB
TAPE 1, 2 }

Tone Controls: BASS ± 10 dB at 30 Hz (TURNOVER
FREQ 150 Hz)
 ± 10 dB at 60 Hz (TURNOVER
FREQ 300 Hz)
TREBLE ± 10 dB at 20 kHz (TURNOVER
FREQ 4 kHz)
 ± 10 dB at 40 kHz (TURNOVER
FREQ 8 kHz)

Filters: LOW 12 dB/oct. below 30 Hz
HIGH 12 dB/oct. above 9 kHz

PREAMPLIFIER SECTION

Harmonic Distortion:	Less than 0.015% at rated output (AEP model) Less than 0.015% at 1W (UK model)
IM Distortion: (60Hz:7 kHz = 4:1)	Less than 0.015% at rated output (AEP model) Less than 0.015% at 1W (UK model)

- Continued on next page -

SAFETY-RELATED COMPONENT WARNING !!

COMPONENTS IDENTIFIED BY SHADING AND  MARK ON THE SCHEMATIC DIAGRAMS, EXPLODED VIEWS AND IN THE PARTS LIST ARE CRITICAL TO SAFE OPERATION. REPLACE THESE COMPONENTS WITH SONY PARTS WHOSE PART NUMBERS APPEAR AS SHOWN IN THIS MANUAL OR IN SUPPLEMENTS PUBLISHED BY SONY.

SONY[®]

SERVICE MANUAL

TA-F7/TA-F7B

Inputs:

	Sensitivity	Impedance	Maximum Input Capability (THD 0.015% at 1 kHz)	S/N (weighting network, input level)
PHONO 1 PHONO 2	2.5 mV (-50 dB)	50 kΩ	250 mV (-10 dB)	75 dB (A, 2.5 mV)
TUNER AUX 1, 2 TAPE 1, 2	150 mV (-14.5 dB)	50 kΩ	—	95 dB (A, 150 mV)

Outputs:

	Output Level	Impedance
REC OUT 1,2	150 mV	10 kΩ
PRE OUTPUT	1 V	1.5 kΩ

POWER AMPLIFIER SECTION

Continuous RMS Power Output: Both channels driven simultaneously
 (rated output) At 20–20,000 Hz
 (Less than 0.015% harmonic distortion) 70 + 70W (8Ω)
 According to DIN 45500
 70 + 70W (8Ω)

Power Bandwidth: 5–40,000 Hz, IHF (8Ω, 0.015 THD)

Damping Factor: 60 (8Ω, 1 kHz)

Harmonic Distortion: Less than 0.015% at rated output
 Less than 0.015% at 1W output

IM Distortion: Less than 0.015% at rated output
 (60 Hz: 7 kHz = 4: 1) Less than 0.015% at 1W output

Frequency Response: dc-100,000 Hz ±₁⁰ dB (1W)

S/N Ratio: Greater than 110 dB, short-circuited input

Residual Noise: Less than 0.12 mV

Inputs: POWER INPUT
 Sensitivity 1V (for rated output)
 Impedance 100 kΩ

Outputs: SPEAKER A, B
 Accept speakers of 8Ω or more
 HEADPHONES
 Accepts low- and high-impedance stereo headphones

0 dB = 0.775 V

MODEL IDENTIFICATION

— Specification Label —

UK model

SONY®	INTEGRATED STEREO AMPLIFIER		
	MODEL NO. TA-F7		
	AC 240V ~	50/60Hz	410W
	SERIAL NO.		
MADE IN JAPAN			

AEP model

SONY®	INTEGRATED STEREO AMPLIFIER		
	MODEL NO. TA-F7		
	AC 220V ~	50/60Hz	400W
	SERIAL NO.		
MADE IN JAPAN			

SONY®	INTEGRATED STEREO AMPLIFIER		
	MODEL NO. TA-F7B		
	AC 240V ~	50/60Hz	410W
	SERIAL NO.		
MADE IN JAPAN			

SONY®	INTEGRATED STEREO AMPLIFIER		
	MODEL NO. TA-F7B		
	AC 220V ~	50/60Hz	400W
	SERIAL NO.		
MADE IN JAPAN			

SECTION 1 OUTLINE

1-1. CIRCUIT DESCRIPTION

1-1-1. Equalizing Amplifier

Refer to Fig. 1-1. The input signal from PHONO 1 or PHONO 2 goes to the gate G1 of the dual-FET differential amplifier Q101 and the feedback signal from the output goes to the gate G2. Q101 amplifies these two input signals, and its output signals at the drains D1 and D2 are in reversed phase. Q106 and D101 are the load of the differential amplifier and compose a current-mirror circuit. This current mirror makes the differential amplifier have more gain and less distortion by re-using the output current in other than the load of the differential amplifier and making it a load current. The output signal appeared in the drain D1 next goes to the base of Q107.

Q107 and Q108 compose a darlington circuit, and this circuit has a proper gain by having a constant-current source Q109. Q102 in the source return of the differential amplifier Q101 is a constant-current source and serves as an infinite impedance against the input signal to the differential amplifier. Transistor Q102 is used instead of a large resistor in this stage, because the dual FET Q101 is drawing a relatively large current from the limited B+ voltage to improve audio quality.

Q103 and Q104 compose a voltage regulator and the voltage V_0 , namely the base-bias of Q102, is maintained constant to make Q102 stable. The current I_1 which flows through the constant-current source Q102 is expressed as

$$I_1 = \frac{V_0 - V_{BE1}}{R106}$$

where $V_0 = V_{BE2} + V_1$

V_1 is determined by I_0 which flows through R112 by V_{BE2}

So, I_1 is determined by V_{BE1} and V_{BE2} and is independent upon B+ and B- voltages, namely I_1 is constant.

Furthermore, this equalizing amplifier is stabilized dc-current-wise by utilizing a dc feedback circuit of Q105 as well as the dependent feedback circuit to produce the RIAA deemphasis curve. Here, Q105 serves as a voltage follower and its dc gain G is determined as

$$G = \frac{R110}{R107} \approx 30 \text{ dB}$$

The lower-side cutoff frequency is determined by R116 and C107 in the gate circuit of Q105.

The RIAA curve to be used as a record amplifier is produced by the feedback components C105, C106, R108, R109, R120 and C109. And the output

signal is fed back to the gate G2 of Q101, thus making a voltage feedback loop.

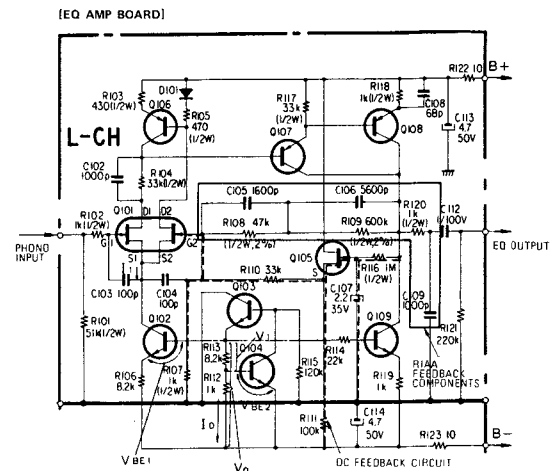

Fig. 1-1.

1-1-2. Power Amplifier

(1) Class-A Amplifier

Refer to Fig. 1-2 and Fig. 1-3. The output signal from the preamplifier section goes to the gate G1 of the dual-FET differential amplifier Q605. The output signal of the class-B amplifier is fed through a feedback route back to the other gate G2 of Q605. These two input signals are amplified in Q605 and mutually reversed-phase output signals are obtained at its drains D1 and D2. Q603, Q604 and Q605 are composing a cascoded differential amplifier, and Q601 and Q602 are its load. Q601 and Q602 also compose a current-mirror circuit and of a push-pull configuration. By utilizing this current-mirror circuit, two outputs are compounded resulting in a high amplification with less distortion.

Due to the high-gain operation of the first stage, Q603 and Q604 lock the drain voltage V_D of Q605 and shift the level, and thus reducing noise component produced by the drain current. The locked drain voltage V_D is expressed as

$$V_D \cong V_{CC} \times \frac{R604}{R603 + R604} \cong 15 \text{ V}$$

The output signal at the drain of Q603 next goes to the class-A cascoded amplifier composed of Q607 and Q608 which has a constant-current load Q611. And its output signal is next applied to and voltage amplified by the following class-B amplifier.

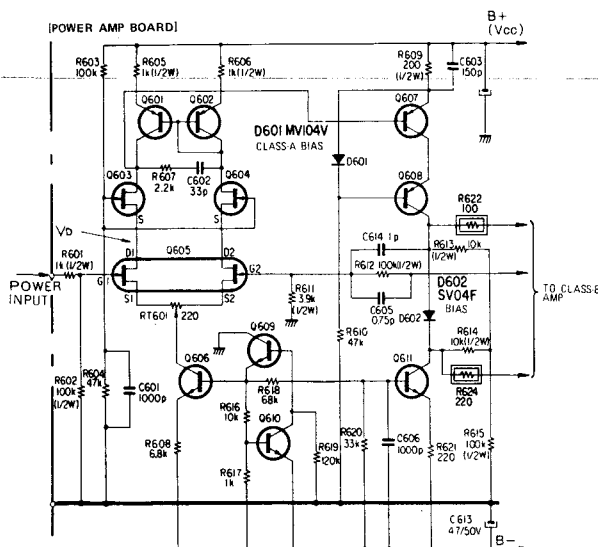

Fig. 1-2.

These two cascoded amplifiers composed of Q603 to Q605, and of Q607 and Q608 are the combination of the common emitter (or source) and

common base (or gate) circuits. In these amplifiers, the mirror effect due to the feedback capacitor from the output side does not present, so they are increasing the transmission capability of high-frequency component. Furthermore, R607 and C602 are connected inbetween the drains of Q603 and Q604 of the first-stage cascoded differential amplifier to make the load impedance low at high frequency, and thus reducing the fluctuation of the amplifier gain.

(B) Class-B Amplifier

Refer to Fig. 1-3. These class-B amplifiers are cascode-type amplifiers utilizing features of the bipolar transistors and V-FETs, and they are improving the signal-transmission characteristics.

Q616 is a class-B driver and emitter follower followed by the final-stage power amplifier. The final-stage power amplifier is a pure-complementary circuit composed of cascode configuration of Q618, Q619 and Q901 to Q903.

When the bipolar transistors and V-FETs are connected in a cascode configuration, V_{CE} of the bipolar transistors Q618 and Q619 becomes the reversed bias of the gate of V-FET and this bias prevents V-FET from damaging, otherwise V-FET may be damaged by a huge current equivalent to I_{DSS} . This reversed bias of V-FET provides a good rejection characteristics against the fluctuation of the power supply voltage. In this configuration, the voltage applied to the bipolar transistor becomes as low as around 15V and bipolar transistors with a high transition frequency f_T can be combined.

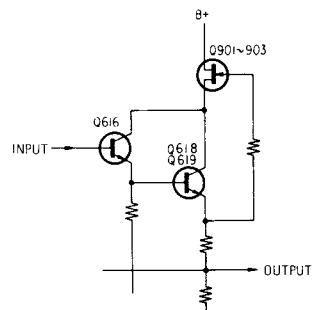

Fig. 1-3.

1-1-3. Power Supply

Refer to Fig. 1-4. This regulated power supply provides a power for the class-B amplifier. This voltage regulator uses a constant-current circuit Q706 in the base-bias circuit of the control transistors Q704 and Q705. And this voltage regulator provides a high input impedance, low output impedance and a good regulation against the fluctuation in the input voltage.

Therefore, a low output impedance is obtainable with a transistor having a large h_{FE} . So in the actual circuit in Fig. 1-4, a darlington configuration is used in the place of Q1 in Fig. 1-5 together with a large resistance R1.

To obtain a good rejection factor against the ripple component, a bootstrap circuit composed of R709 and D711 is used.

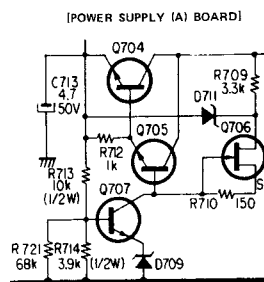

Fig. 1-4.

Fig. 1-5 shows the basic voltage-regulating circuit.

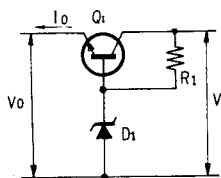

Fig. 1-5.

The voltage regulation factor is expressed as

$$\frac{\Delta V_o}{\Delta V_i} \approx \frac{R_d}{R_1 + R_d}$$

where, ΔV_o = fluctuation of output voltage

ΔV_i = fluctuation of input voltage

R_{d1} = active resistance of D1

Accordingly, on a constant R_{d1} , the larger R1 the better a voltage regulation. In the circuit in Fig. 1-4, a good voltage regulation is obtained by utilizing an FET-type constant-current source and a large R1.

The output impedance of the circuit in Fig. 1-5 is expressed as

$$R_o \approx \frac{\Delta V_o}{\Delta I_o}$$

$$\approx \frac{R_b + R_d}{1 + h_{FE}}$$

where, R_b = base resistance of Q1

h_{FE} = current amplification factor of Q1

1-2. BLOCK DIAGRAM

Note: * The capacitor indicated by * is an only coupling capacitor in TONE OFF mode except for signal path from PHONO (1) and PHONO (2) to EQ amp output.

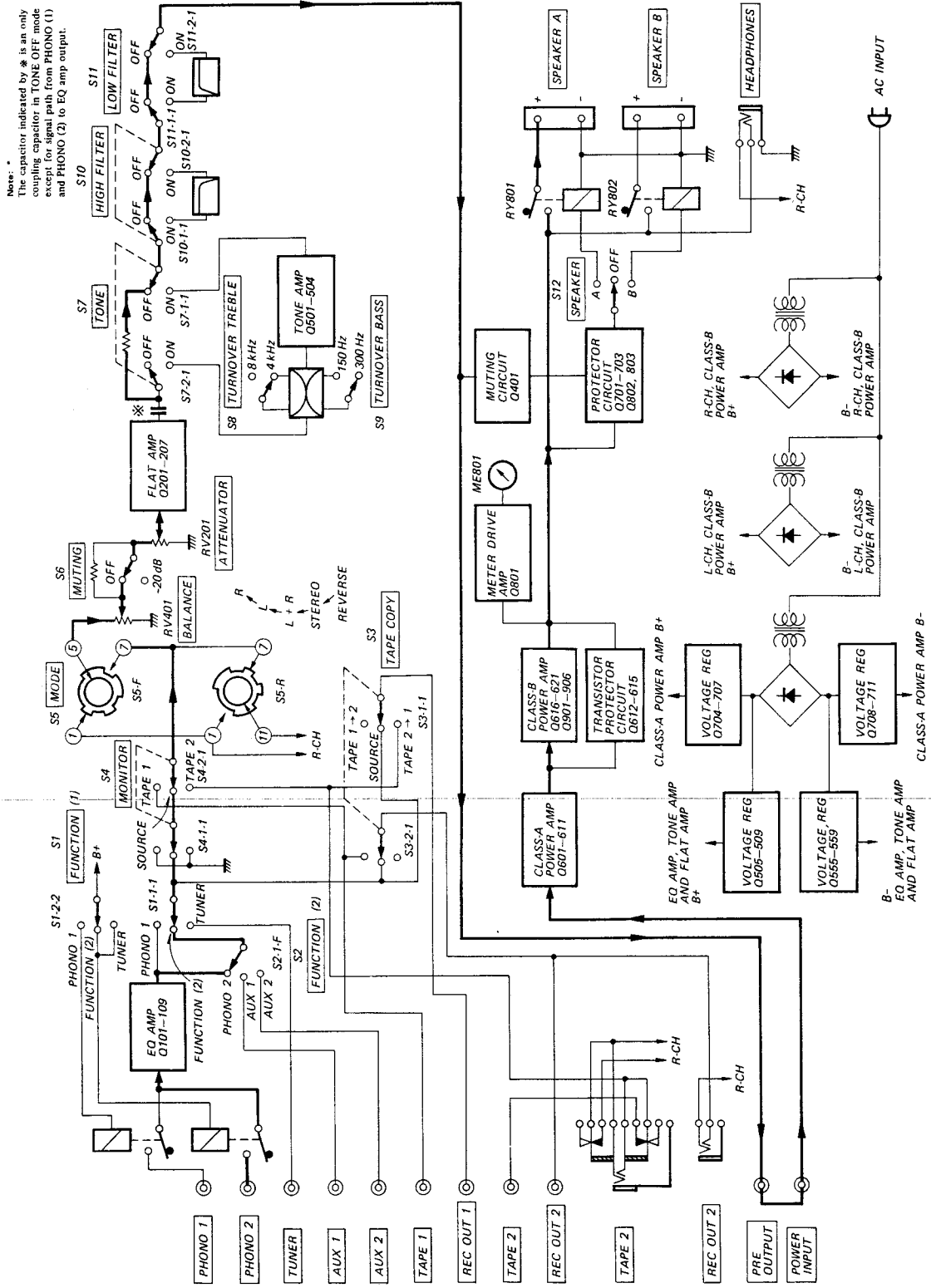

SECTION 2
DISASSEMBLY

Note: Remove in the numerical order.

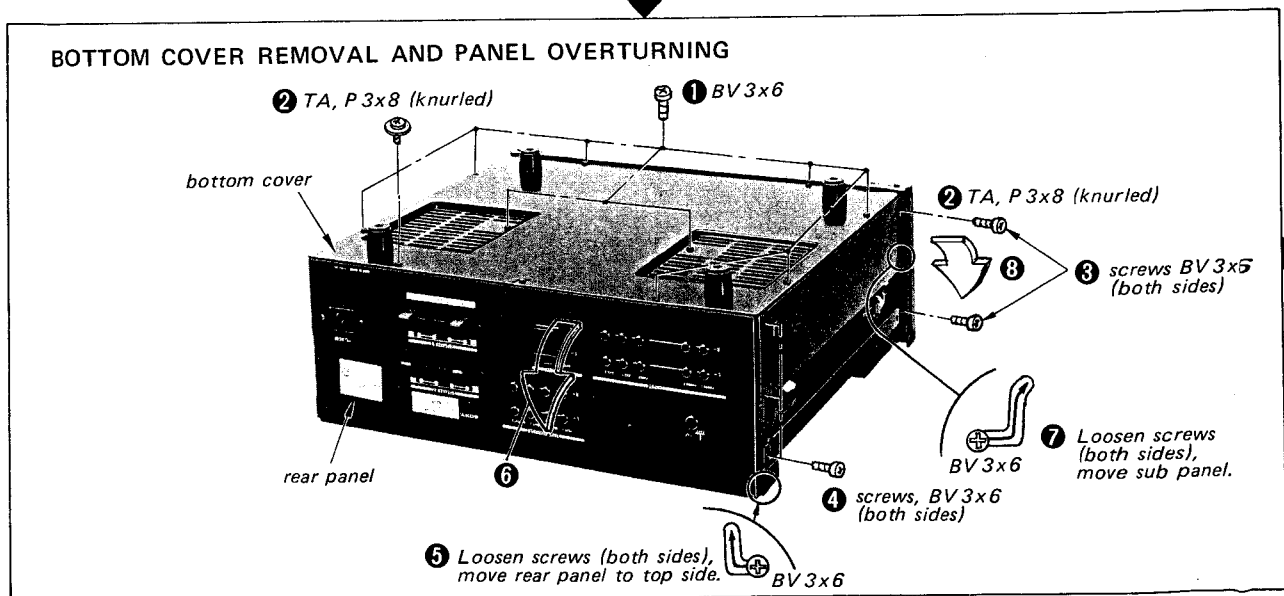
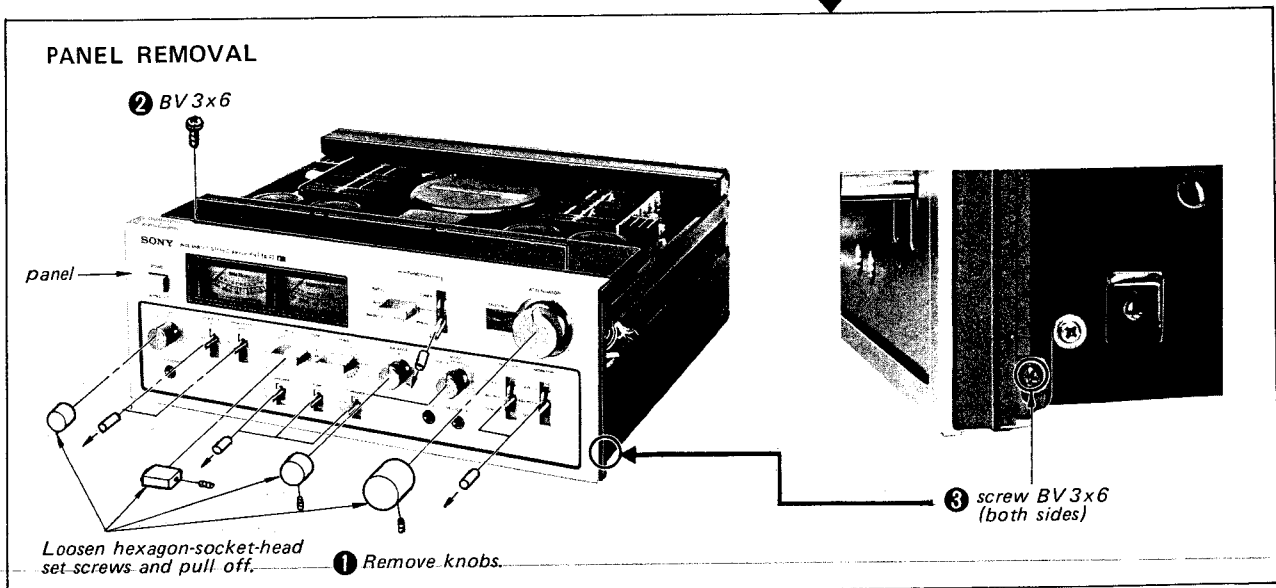
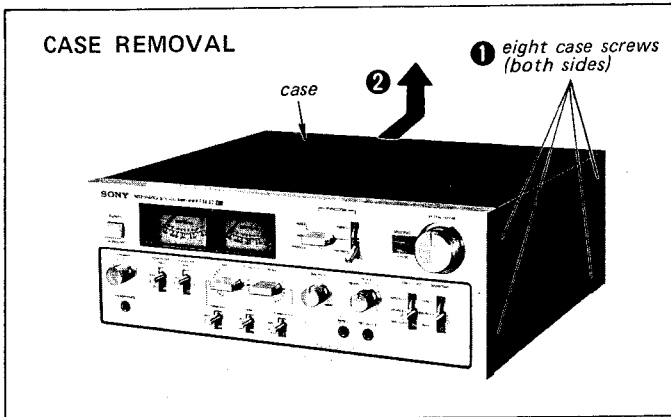

POWER V-FET REPLACEMENT

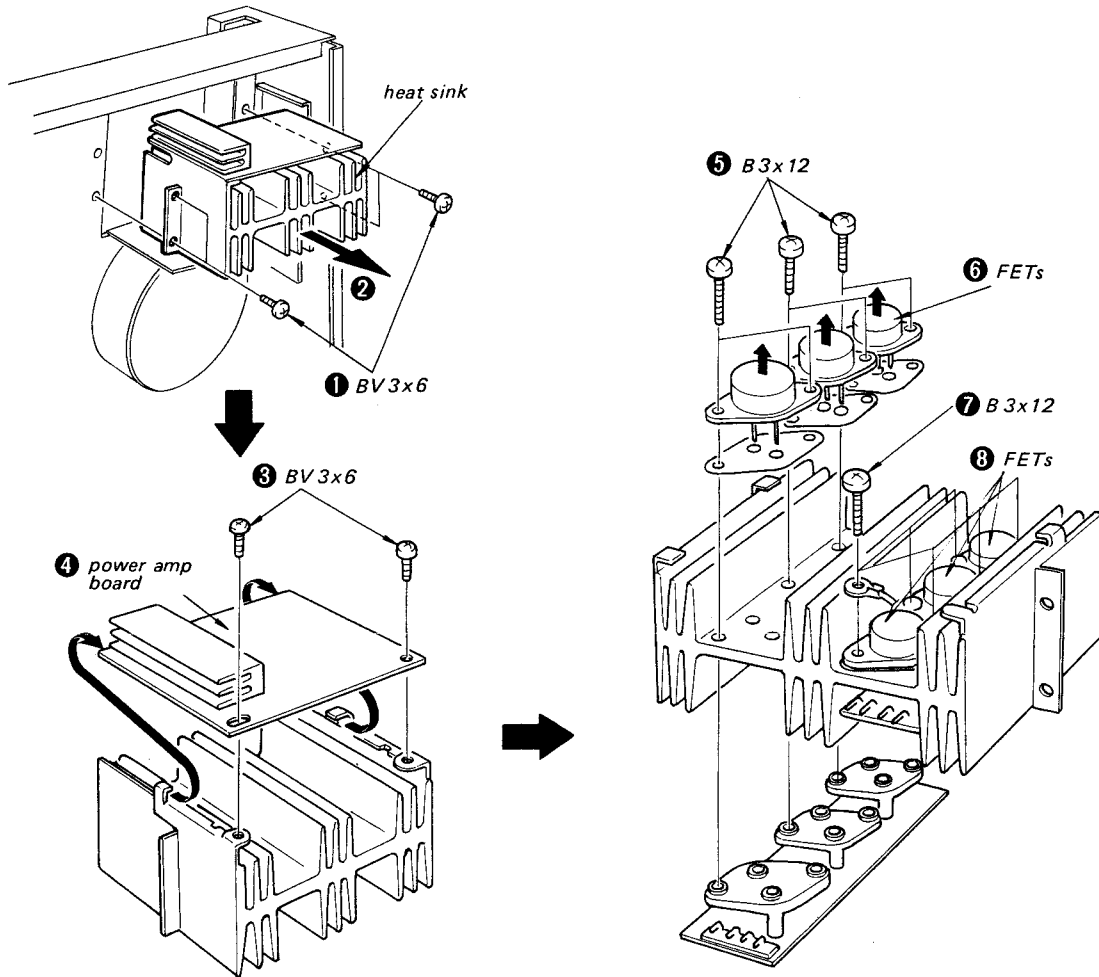

CHECKING OF THE BOARD

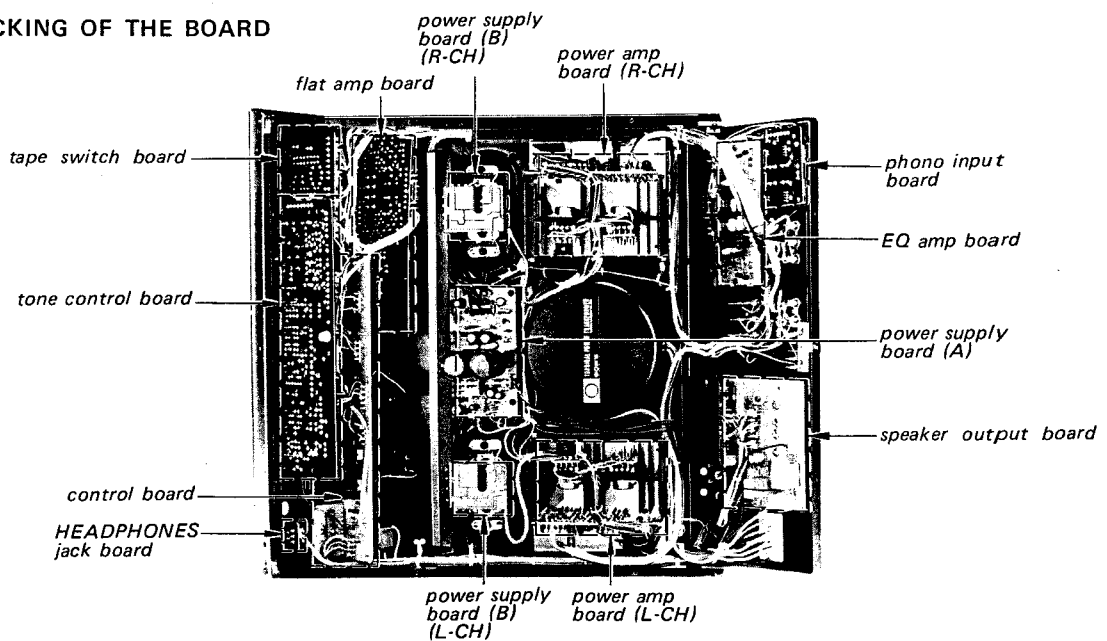

SECTION 3
ADJUSTMENT

Note: 1. As outlined in the circuit description, this set uses bipolar transistors and V-FETs in cascode circuit to maintain stable biasing. When replacing the three P-channel V-FETs 2SK60 and/or the three N-channel V-FETs 2SJ18 in each channel, use three matched ones which have the same V_p (pinch-off voltage)-rank figure printed on them as shown below. The fluctuation of the V_p rank of the three can be acceptable on one-rank-difference basis.

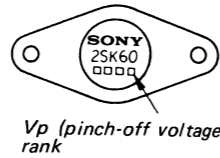

- When the power transistors are replaced, be sure to perform the DC BIAS and DC BALANCE adjustments again.
- Perform DC BIAS and DC BALANCE adjustments a few minutes passed after POWER switch turned ON.
- Repeat DC BIAS and DC BALANCE adjustments a few times because they affect each other.

DC Balance Adjustment

- Connect a dc millivoltmeter to SPEAKER terminals.
- Turn POWER switch ON. Adjust RT601 (L-CH) and RT651 (R-CH) for 0V reading on the millivoltmeter.

DC Bias Adjustment

- Connect a VOM to the dc-bias check points.
- With no input signal, adjust RT602 (L-CH) and RT652 (R-CH) for 12 mV reading on VOM.

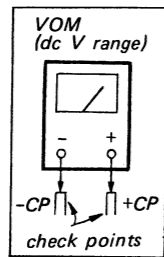

Note: When the controls are turned in the arrowed direction ✱, voltage reading increases. Same power-amp circuit boards are used in both L- and R-channels. Component reference numbers printed on the circuit board are different from the circuit and mounting diagrams.

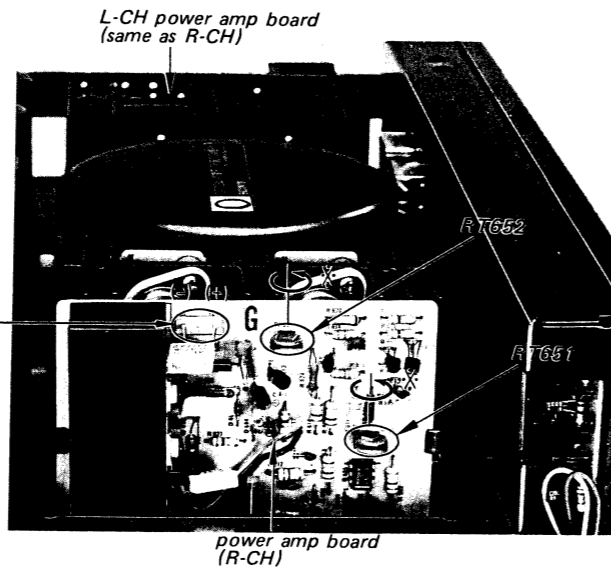

Power Meter Adjustment

Setting: ATTENUATOR control: maximum
HIGH FILTER switch: OFF
LOW FILTER switch: OFF
MONITOR switch: SOURCE
FUNCTION switch: TUNER

TONE controls: mechanical mid
BALANCE control: mechanical mid
MUTING switch: OFF

Procedure:

- Adjust attenuator for 8.9V (10W) reading on VTVM.
- Adjust RT801 (L-CH) and RT851 (R-CH) so that power meters indicate 10W.

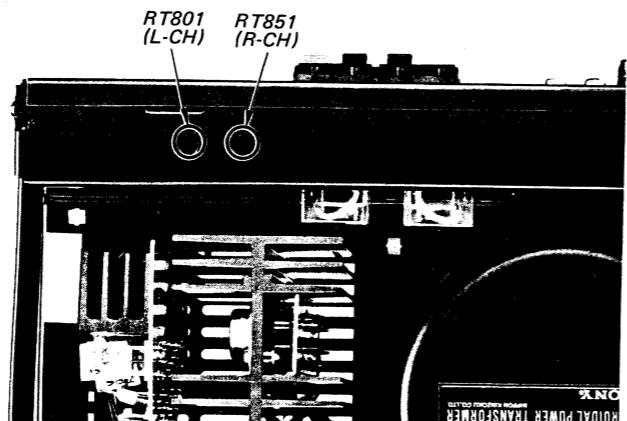
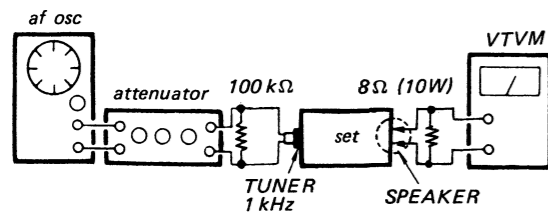

Replacement Semiconductors

For replacement, use semiconductors except in ().

Q101, 151: 2SK97

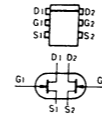

Q102-104
Q152-154
Q203, 205, 206
Q253, 255, 256 } 2SC1128

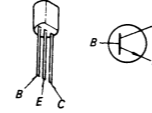

Q105, 155: 2SK43-2 (2SK43)

Q201, 202 } 2SK43-3A (2SK43)

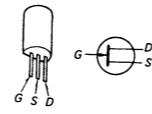

Q106, 107 } 2SA639S

Q156, 157 } 2SA896

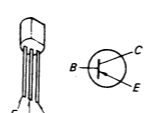

Q109, 159
Q207, 257 } 2SC1811

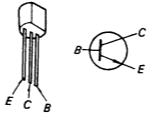

D101, 151: 1S1555

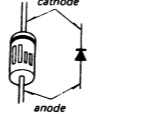

Note:

- Color code of sleeving over the end of the jacket.

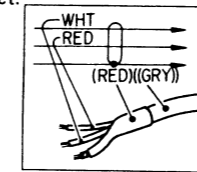

- ⊗ : Through hole.
- ▨ : component-side pattern.
- ▩ : B+ pattern.
- ▧ : B- pattern.

CIRCUIT BOARD LOCATION

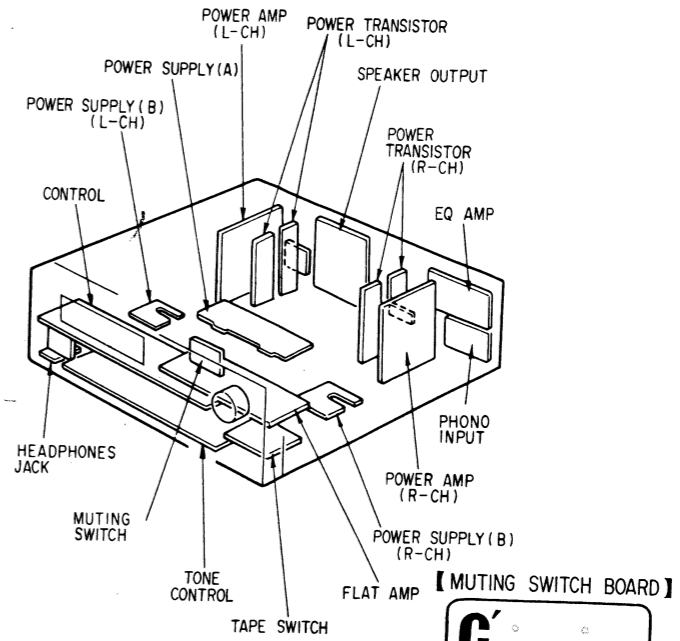

Q	206	203	207	204
D		205	202	201

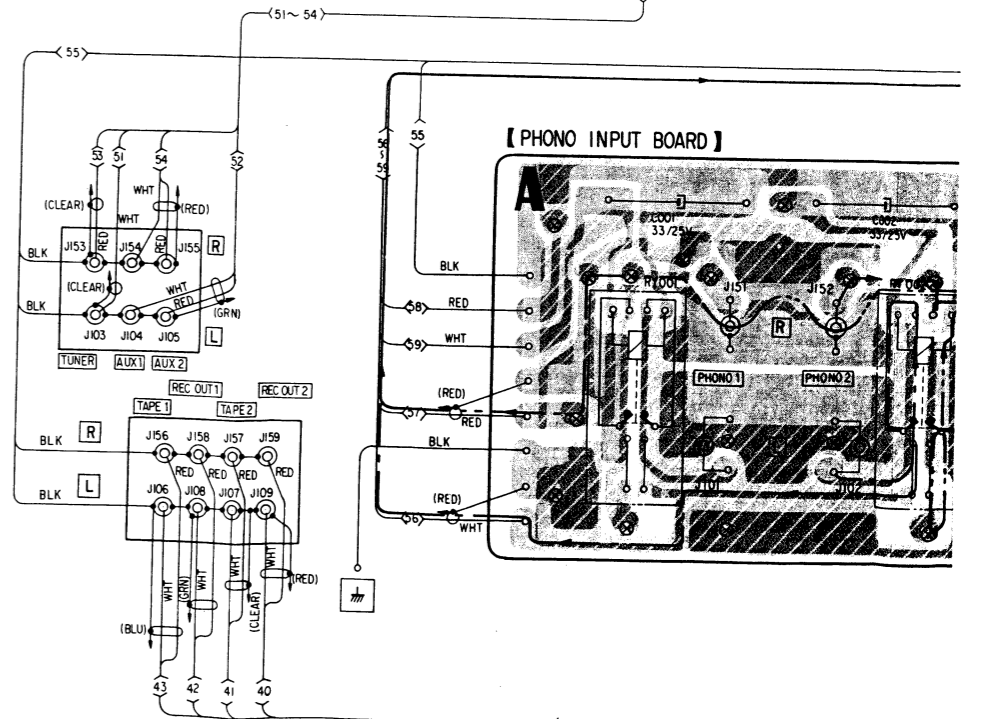
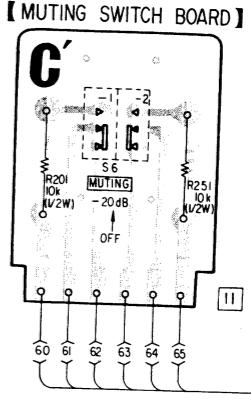
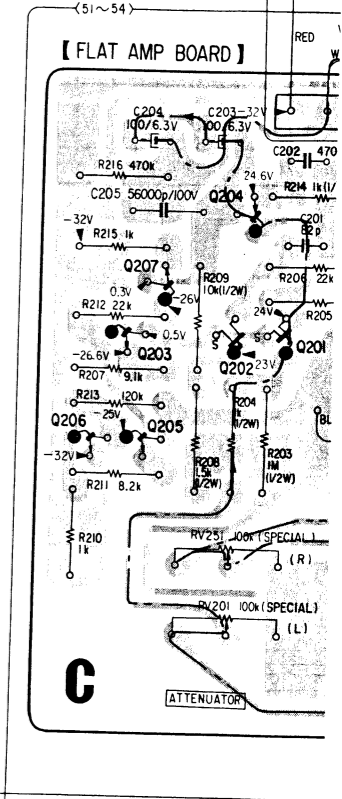

SECTION 4
DIAGRAMS

4-1. MOUNTING DIAGRAM (1) - Preamp Section - - Conductor Side - -

and, be
1 DC
ANCE
after
adjust-
each

Replacement Semiconductors
For replacement, use semiconductors except in ().

Q101, 151: 2SK97

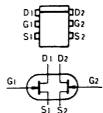

Q102-104
Q152-154
Q203, 205, 206
Q253, 255, 256 : 2SC1128

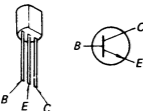

Q105, 155: 2SK43-2 (2SK43)
Q201, 202 : 2SK43-3A (2SK43)
Q251, 252 :

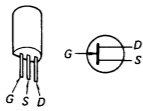

Q106, 107 : 2SA639S
Q156, 157 :
Q108, 158
Q204, 254 : 2SA896

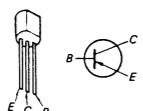

Q109, 159 : 2SC1811
Q207, 257 :

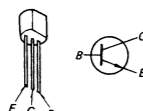

D101, 151: 1S1555

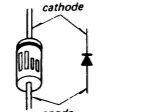

Note:
• Color code of sleeving over the end of the jacket.

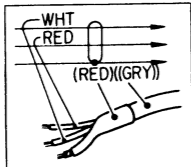

- ⊗ : Through hole.
- [Hatched] : component-side pattern.
- [Dotted] : B+ pattern.
- [Stippled] : B- pattern.

CIRCUIT BOARD LOCATION

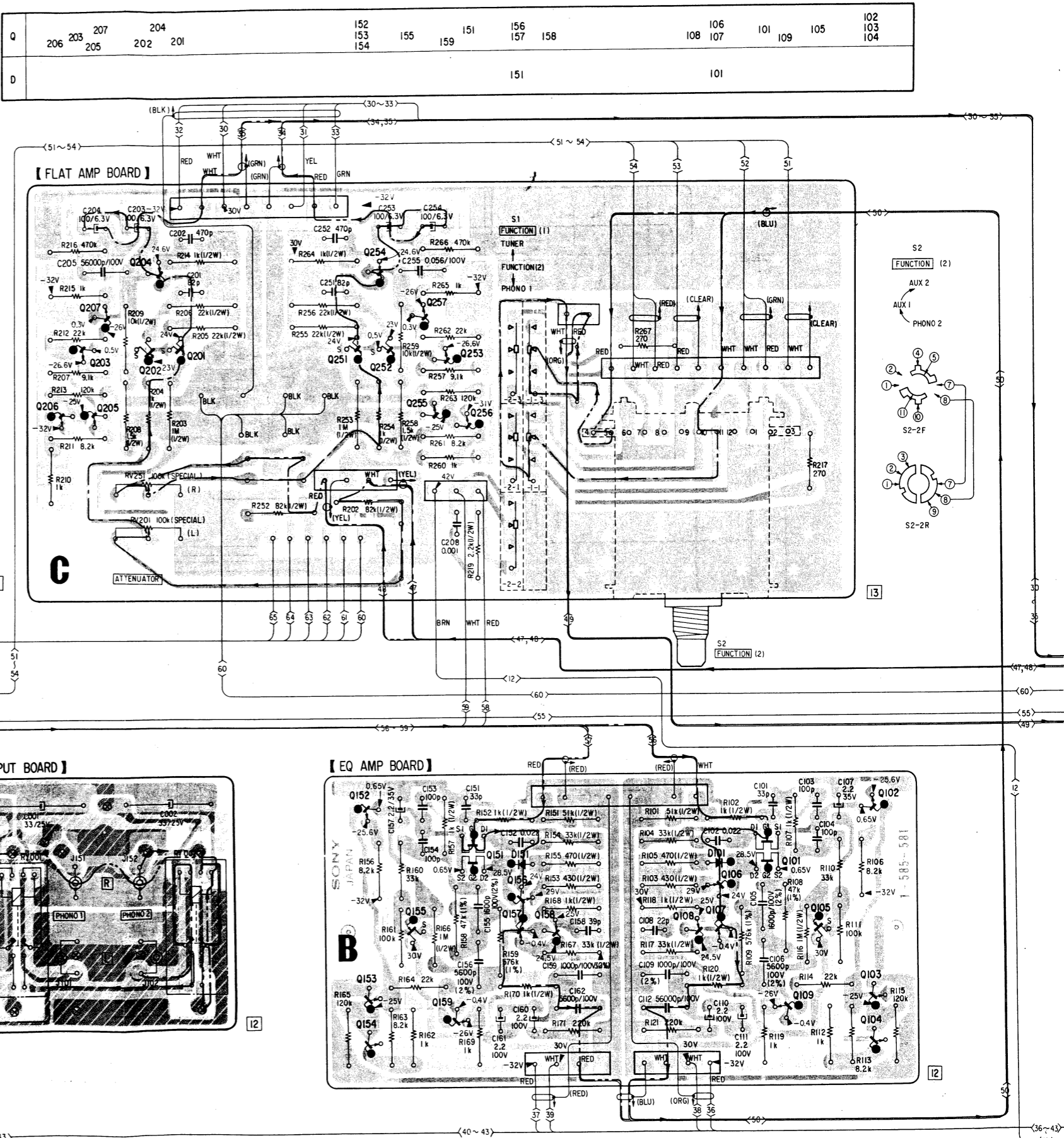
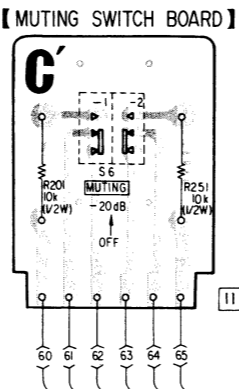
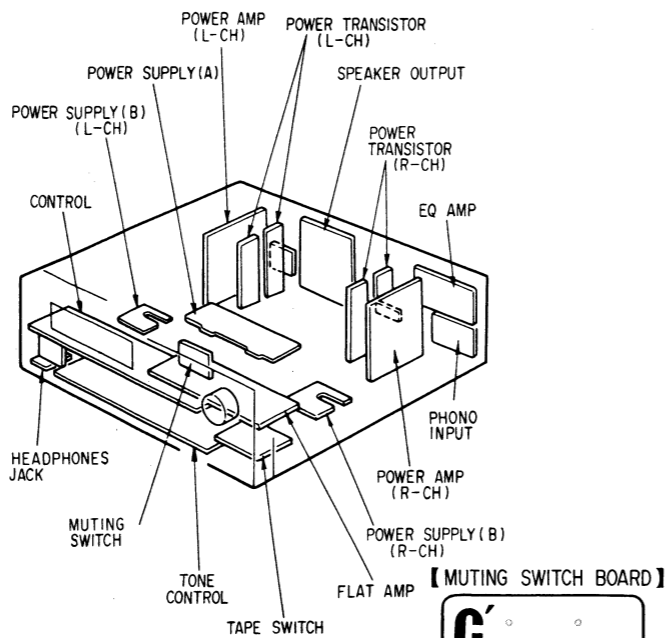

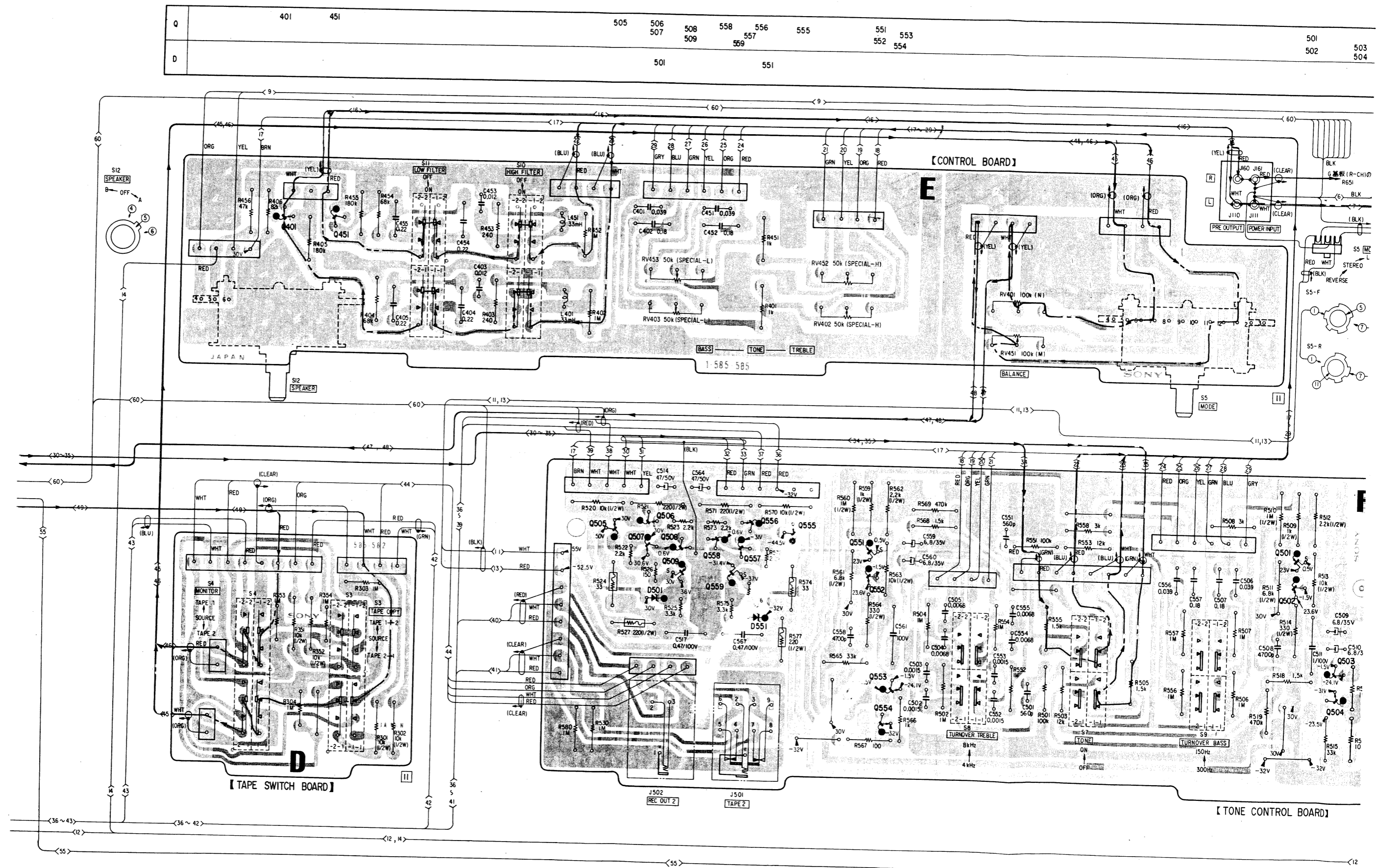

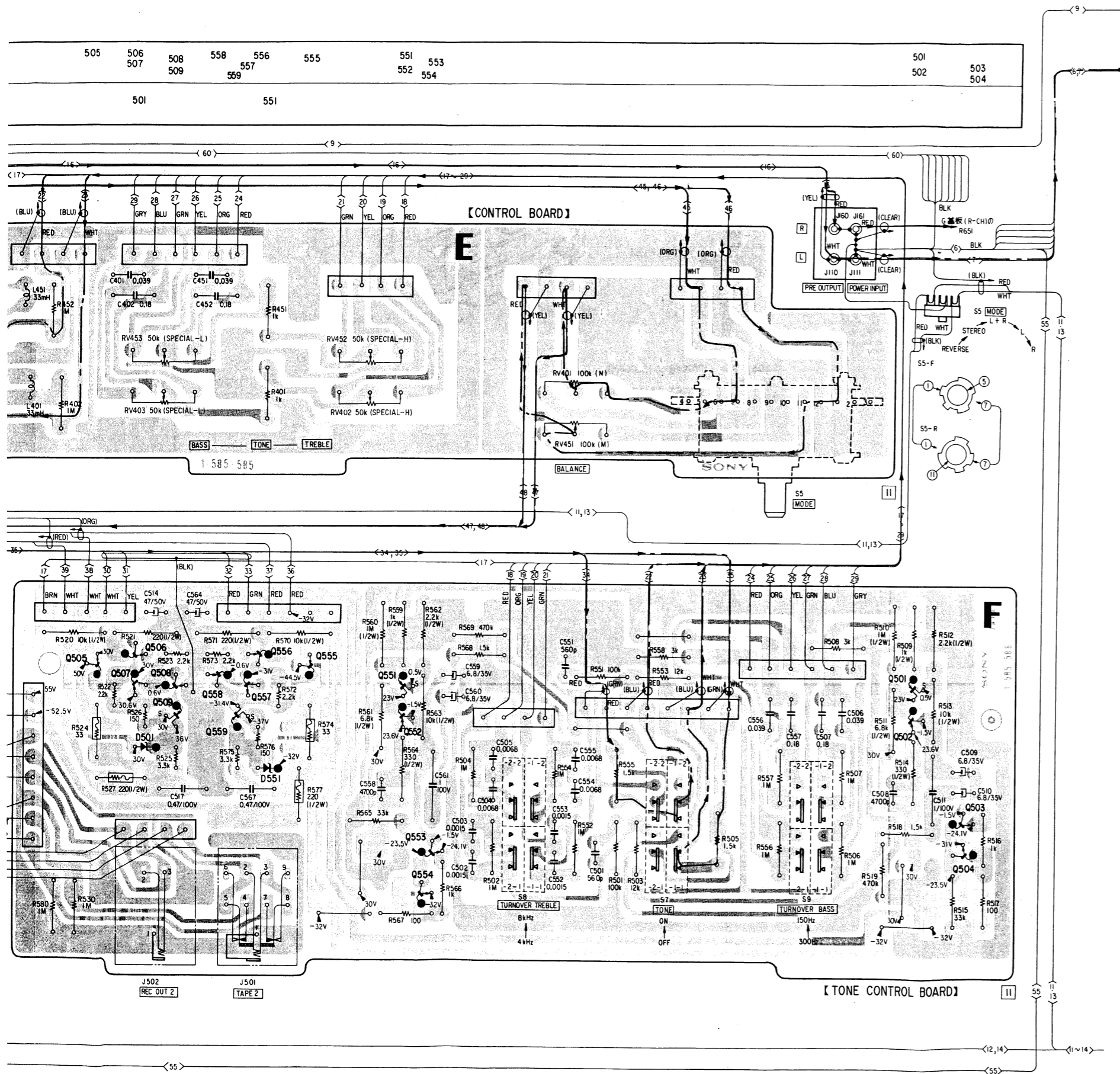

Replacement Semiconductors

For replacement, use semiconductors except in ().

Q401, 451: 2SC1636

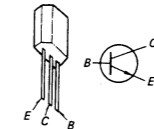

Q504, 554: 2SC1128

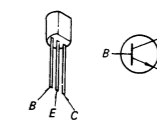

Q501, 551: 2SK43-3A (2SK43)

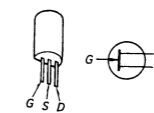

Q505: 2SC1061

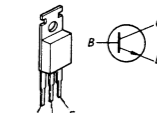

Q502, 552: 2SA896

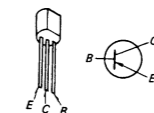

Q507, 556, 558: 2SA899

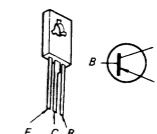

Q503, 553: 2SC1811

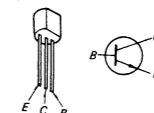

Q509, 559: 2SK42-2 (2SK42)

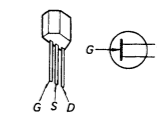

Q506, 508, 557: (2SC945)

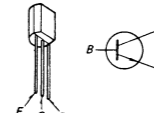

Q555: 2SA671

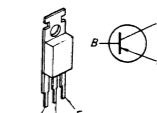

Q506, 508, 557: 2SC634A

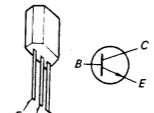

D501, 551: EQA01-07

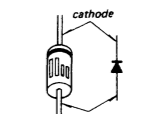

Note:

- Color code of sleeving over the end of the jacket.

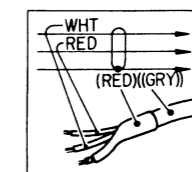

- [Pattern] : B+ pattern.
- [Pattern] : B- pattern.

TA-F7/TA-F7B TA-F7/TA-F7B

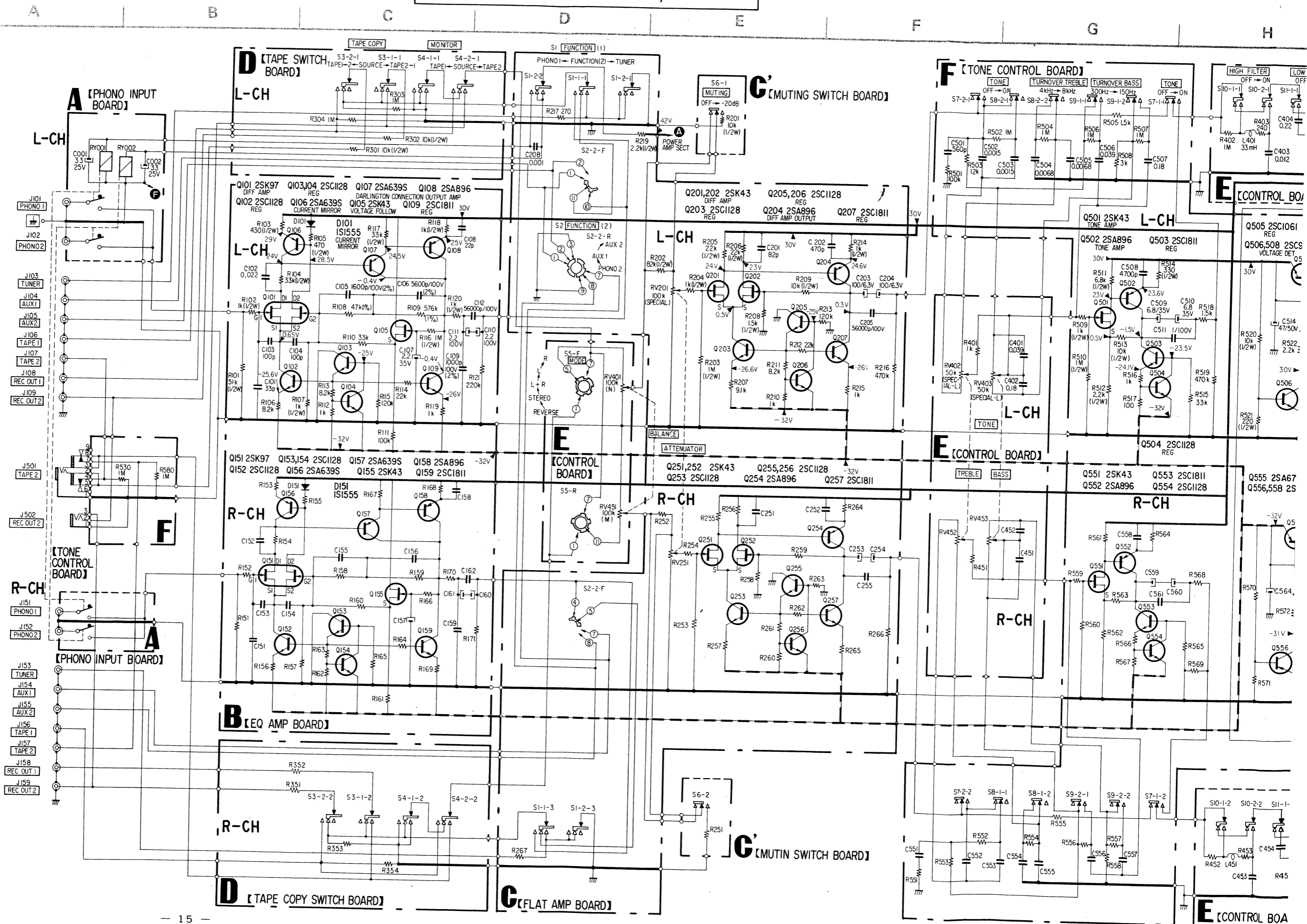

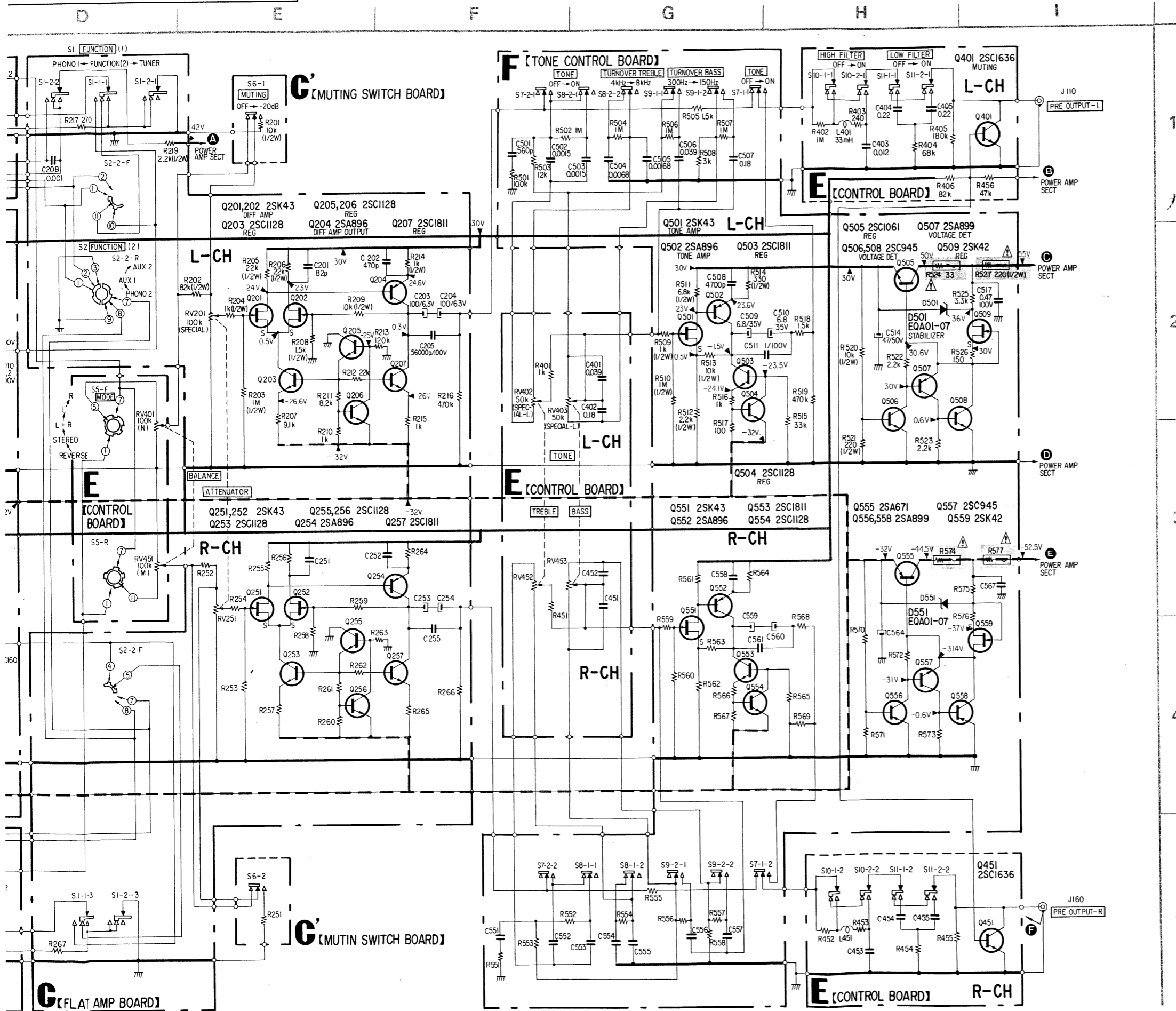

Note: The components identified by shading and Δ mark are critical for safety. Replace only with part number specified.

- Note:
- Components for right channel have same values as for left channel. Reference numbers are coded from.
 - All capacitors are in μF unless otherwise noted. $\text{pF} = \mu\text{F}$ 50WV or less are not indicated except for electrolytics.
 - All resistors are in ohms, $\frac{1}{4}\text{W}$ unless otherwise noted. $\text{k}\Omega = 1000\Omega$, $\text{M}\Omega = 1000\text{k}\Omega$
 - $\text{---}\text{---}$: fusible resistor.
 - 0% indicates component tolerance.
 - \blacksquare : B+ bus.
 - \blacksquare : B- bus.
 - \square : panel designation.
 - Readings are taken under no signal conditions with a VOM (20 $\text{k}\Omega/\text{V}$).
 - Switch

Ref. No.	Switch	Position
S1	FUNCTION (1)	FUNCTION (2)
S2	FUNCTION (2)	PHONO 2
S3	TAPE COPY	SOURCE
S4	MONITOR	SOURCE
S5	MODE	REVERSE
S6	MUTING	OFF
S7	TONE	OFF
S8	TURNOVER TREBLE	4 kHz
S9	TURNOVER BASS	300 Hz
S10	HIGH FILTER	OFF
S11	LOW FILTER	OFF

Replacement Semiconductors

For replacement, use semiconductors except in ().

- Q601, 602
Q651, 652
Q612, 615
Q662, 665
Q702, 802
Q803 : 2SA678
- Q613, 614
Q663, 664
Q701, 703
Q801, 851 : 2SC634A
- Q904-906
Q954-956 : 2SJ18

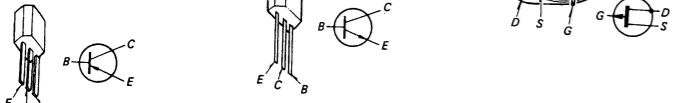

- Q603, 604
Q653, 654 : 2SK30A-GR (2SK30A)
- Q616, 666 : 2SC1124
- D601, 651: (MV104V)

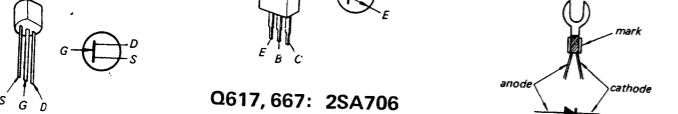

- Q605, 655: 2SK97
- Q617, 667: 2SA706
- D601, 651: KB462S

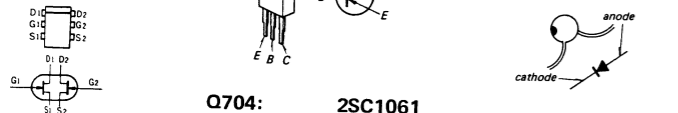

- Q606, 609
Q610, 656 : 2SC1128
- Q618, 619
Q668, 669 : 2SC1173
- D602, 652: SV04F

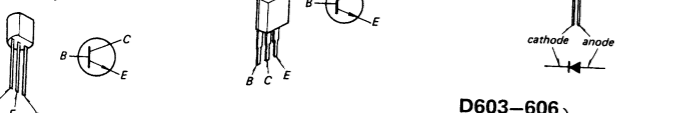

- Q607, 657: 2SA639S
- Q608, 658: 2SA896
- Q710: 2SA671
- Q620, 621 : 2SA473
- Q670, 671 : 2SA473
- D603-606
D653-656 : 1S1555
- D707 : 10E2
- D701-706: 10E2
- D708: 10E2 (10E1)
- D801, 802 : 1T22A
- D851, 852 : 1T22A

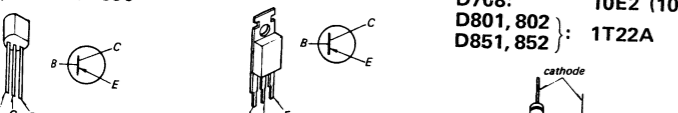

- Q611, 661: 2SC1811
- Q706, 711: 2SK42-2 (2SK42)
- D709, 710: EQB01-11Z (EQA01-11R)
- D711, 712: EQB01-07 (EQA01-07)

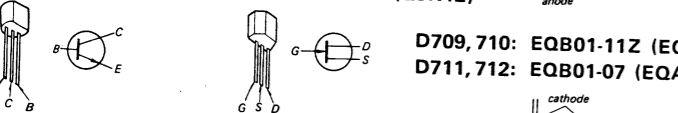

- Q705, 707: (2SC945)
- Q708, 709: 2SA899
- D751, 752: S5VB

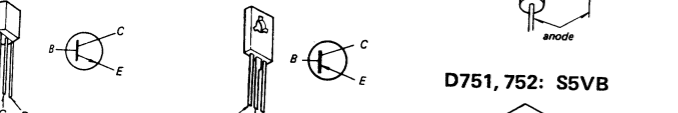

- Q705, 707: 2SC634A
- Q901-903
Q951-953 : 2SK60



Note:
 • Color code of sleeving over the end of the jacket. • : B+ pattern.
 • : B- pattern.

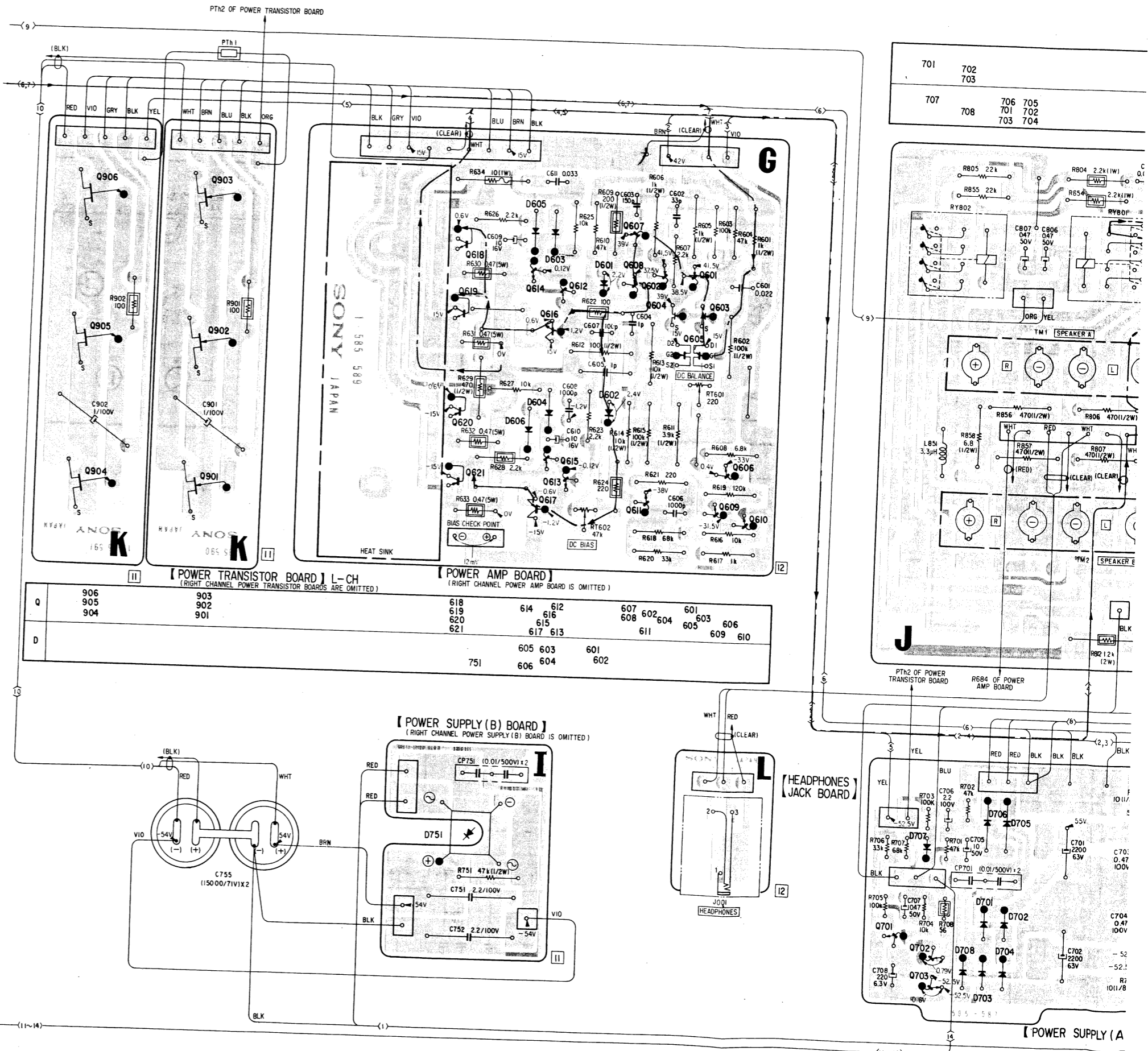
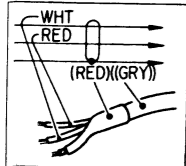

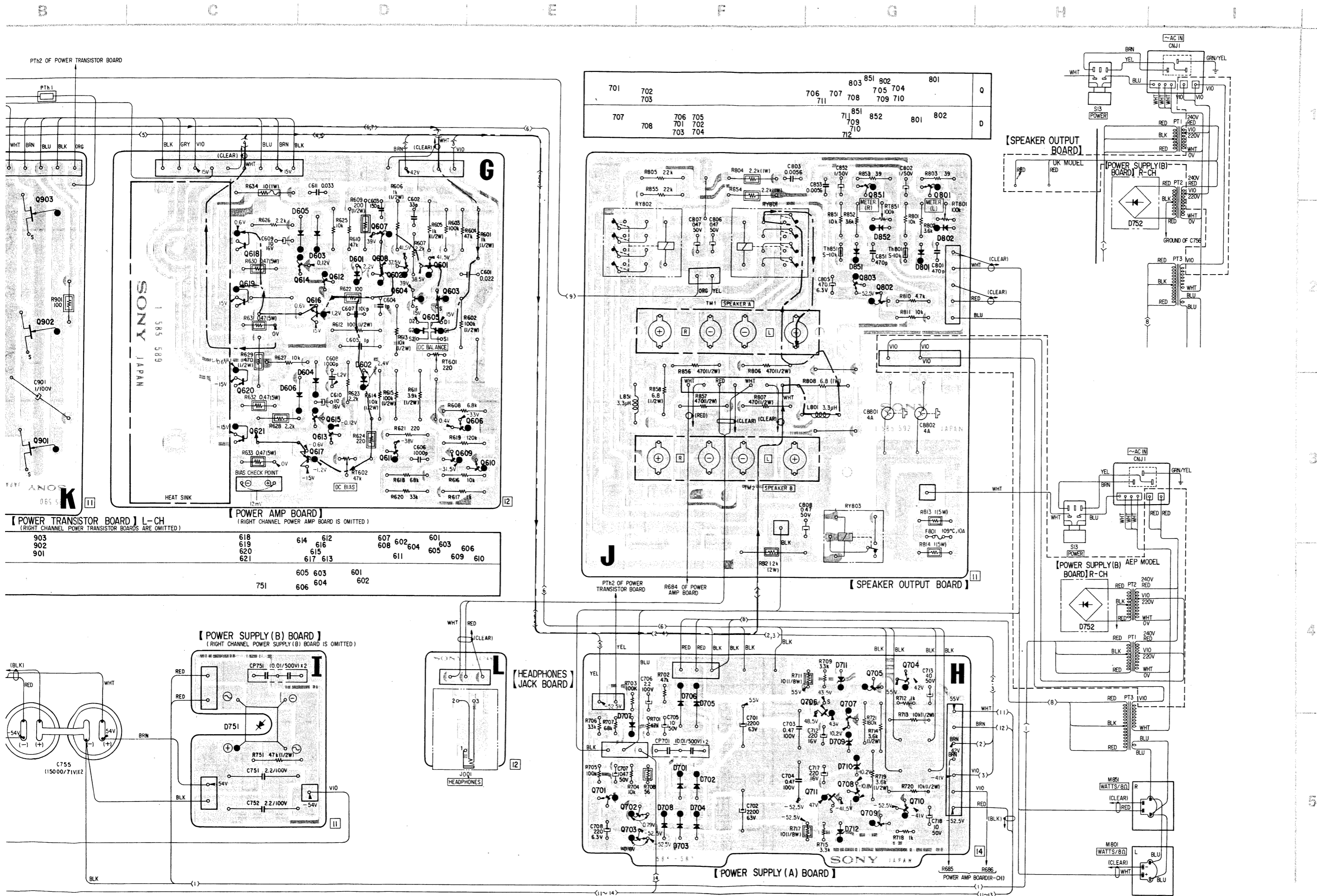

701	702	803	802	801	
703		706	707	708	705 704
		711	712	710	709 710
707	708	706	705	701	702
		703	704	703	704

【POWER TRANSISTOR BOARD】 L-CH
(RIGHT CHANNEL POWER TRANSISTOR BOARD IS OMITTED.)

903	618	614	612	607	602	601
902	619	616	615	608	604	603
901	620	617	613	611	605	606
	621	605	603	601	609	610
		751	606	604	602	

【SPEAKER OUTPUT BOARD】

【POWER SUPPLY (B) AEP MODEL BOARD】 R-CH

【POWER SUPPLY (A) BOARD】

【HEADPHONES JACK BOARD】

【POWER SUPPLY (B) BOARD】

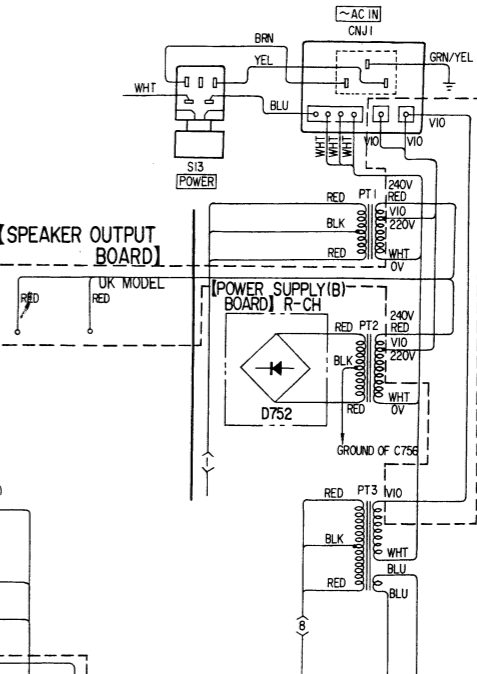
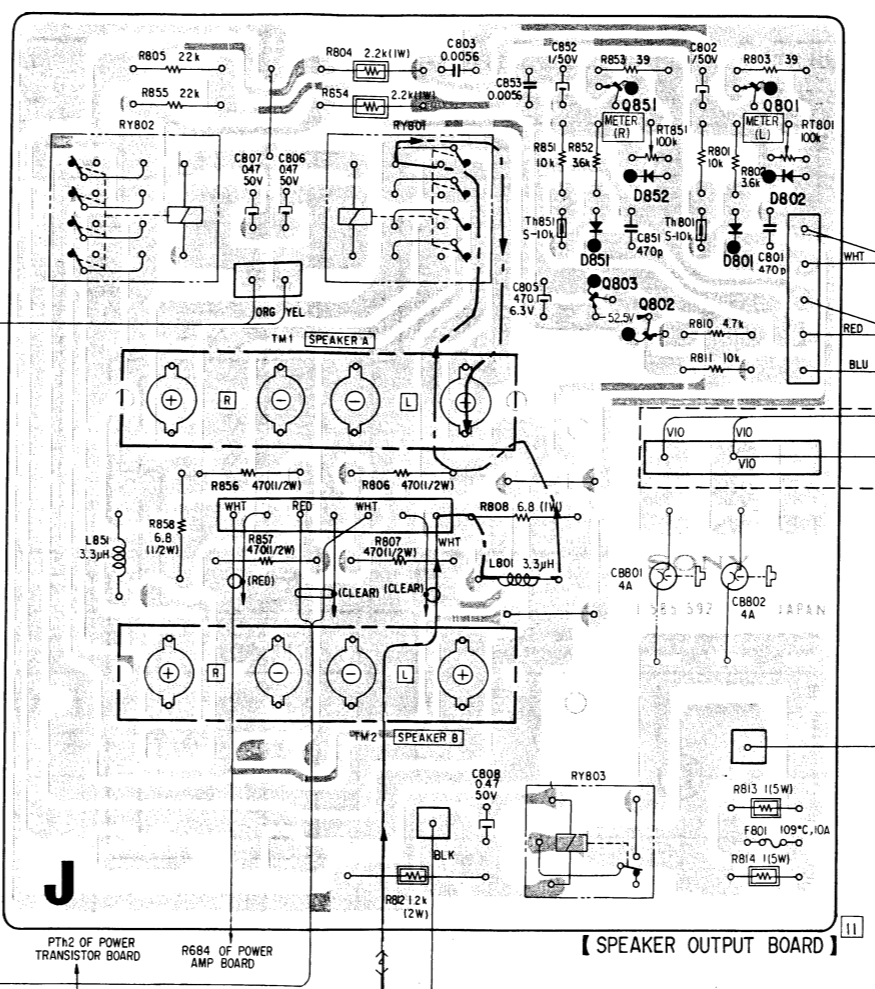
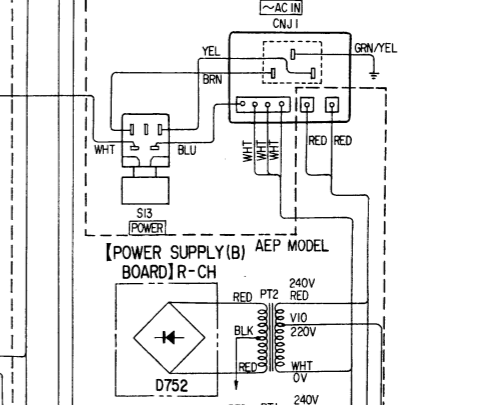
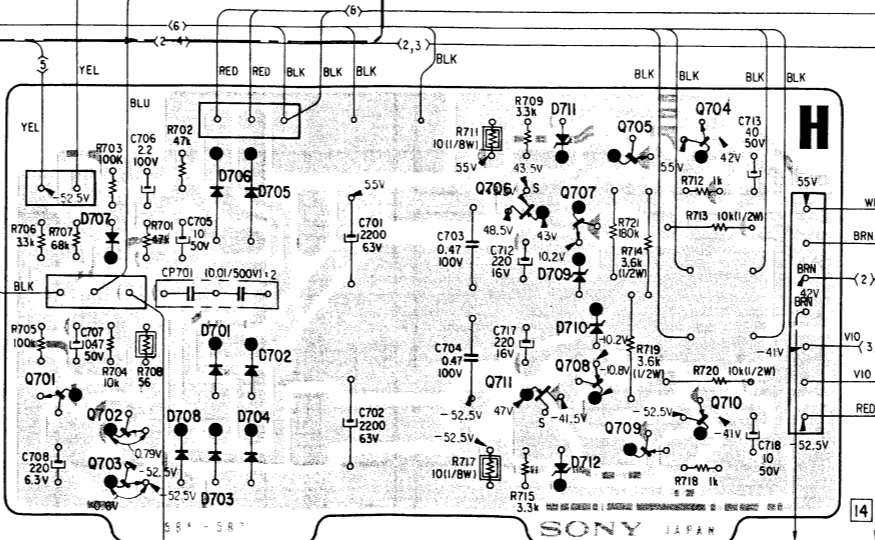
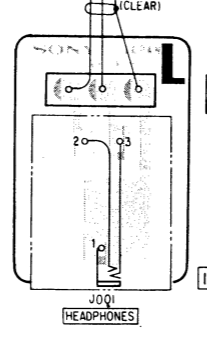
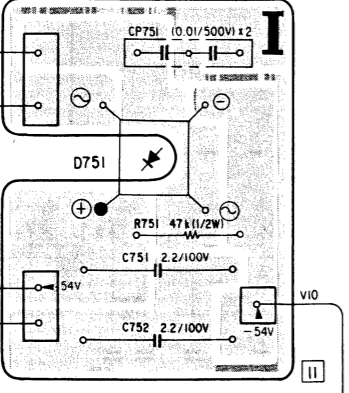
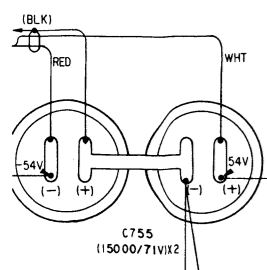

TA-F7/TA-F7B TA-F7/TA-F7B

4-5. SCHEMATIC DIAGRAM - Power Amplifier and Power Supply Sections -

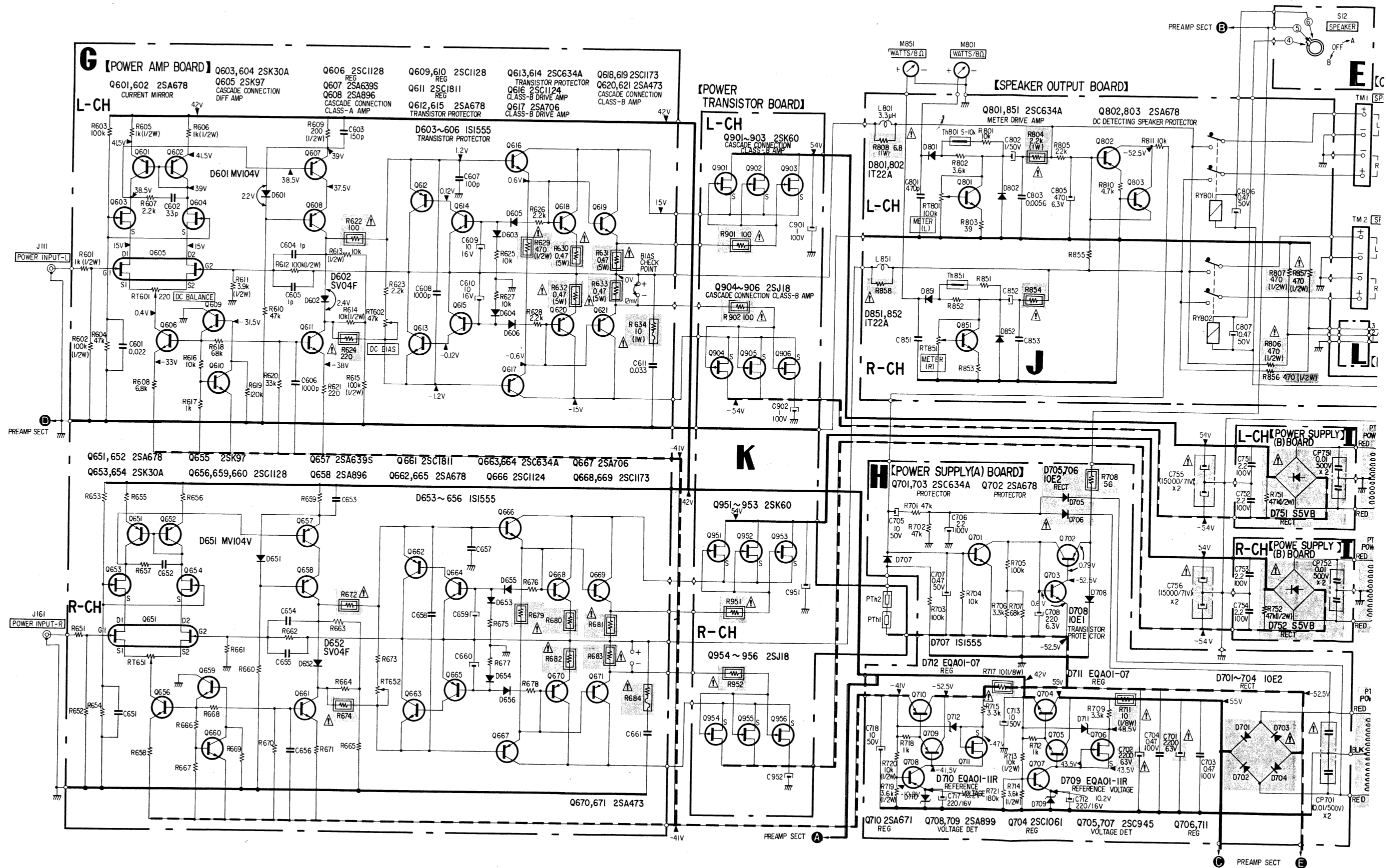

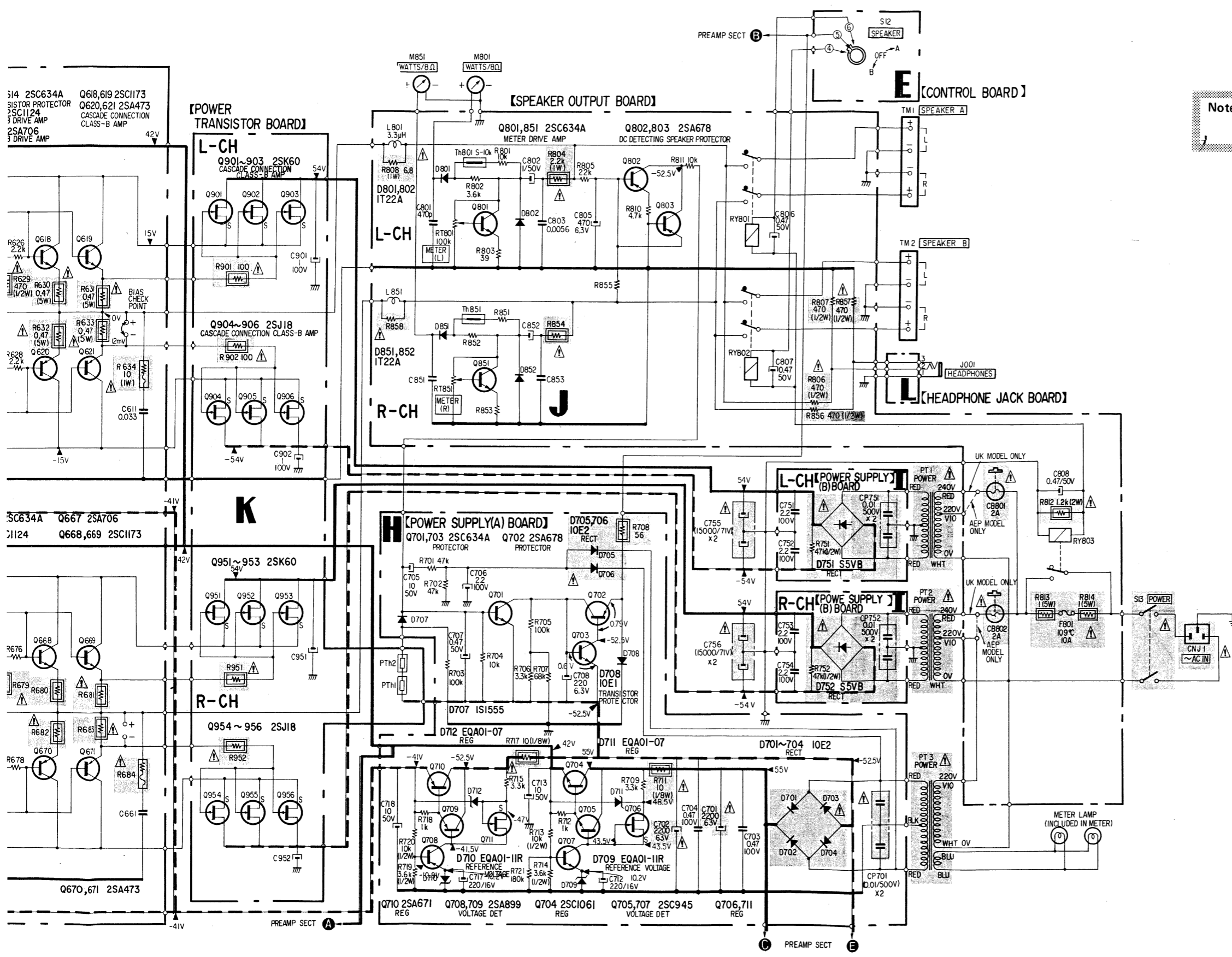

Note: The components identified by shading and Δ mark are critical for safety. Replace only with part number specified.

- Note:
- Components for right channel have same values as for left channel. Reference numbers are coded from.
 - All capacitors are in μF unless otherwise noted. $\text{pF} = \mu\mu\text{F}$ 50WV or less are not indicated except for electrolytics.
 - All resistors are in ohms, $\frac{1}{4}\text{W}$ unless otherwise noted. $\text{k}\Omega = 1000\Omega$, $\text{M}\Omega = 1000\text{k}\Omega$
 - \square : nonflammable resistor.
 - \square : fusible resistor.
 - \square : B+ bus.
 - \square : B- bus.
 - \square : panel designation.
 - \square : adjustment for repair.
 - Readings are taken under no signal conditions with a VOM (20 $\text{k}\Omega/\text{V}$).
 - Switch

Ref. No.	Switch	Position
S12	SPEAKER	OFF
S13	POWER	OFF

(-) = slotted head

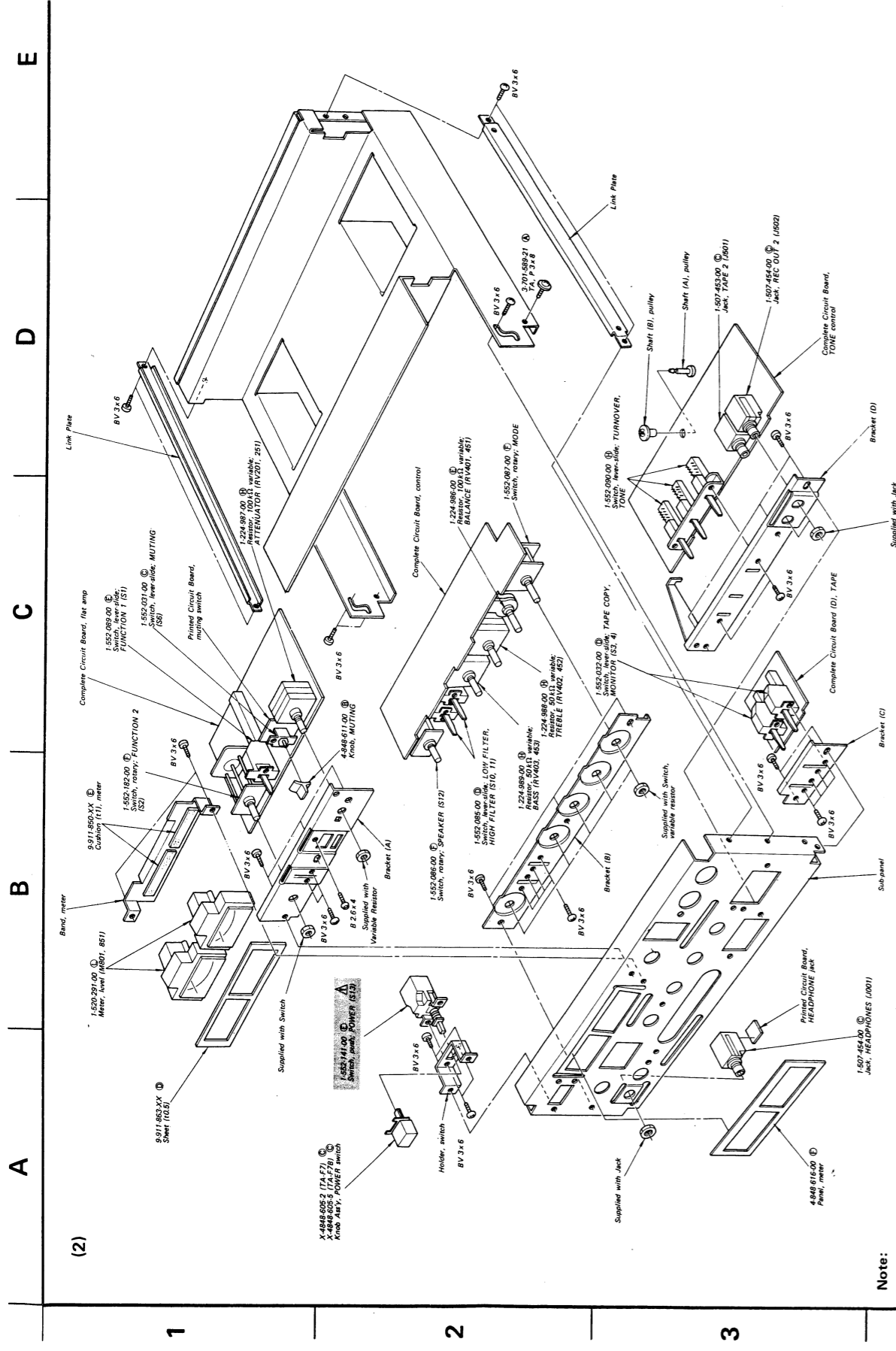

Note:

- Items with no part number and/or no description are not stocked because they are seldom required for routine service.
- All screws are Phillips (cross recess) type unless otherwise noted.
- (-) = slotted head

• Circled letters (A to Z) are applicable to European models only.

Note: The components identified by shading and Δ mark are critical for safety. Replace only with part number specified.

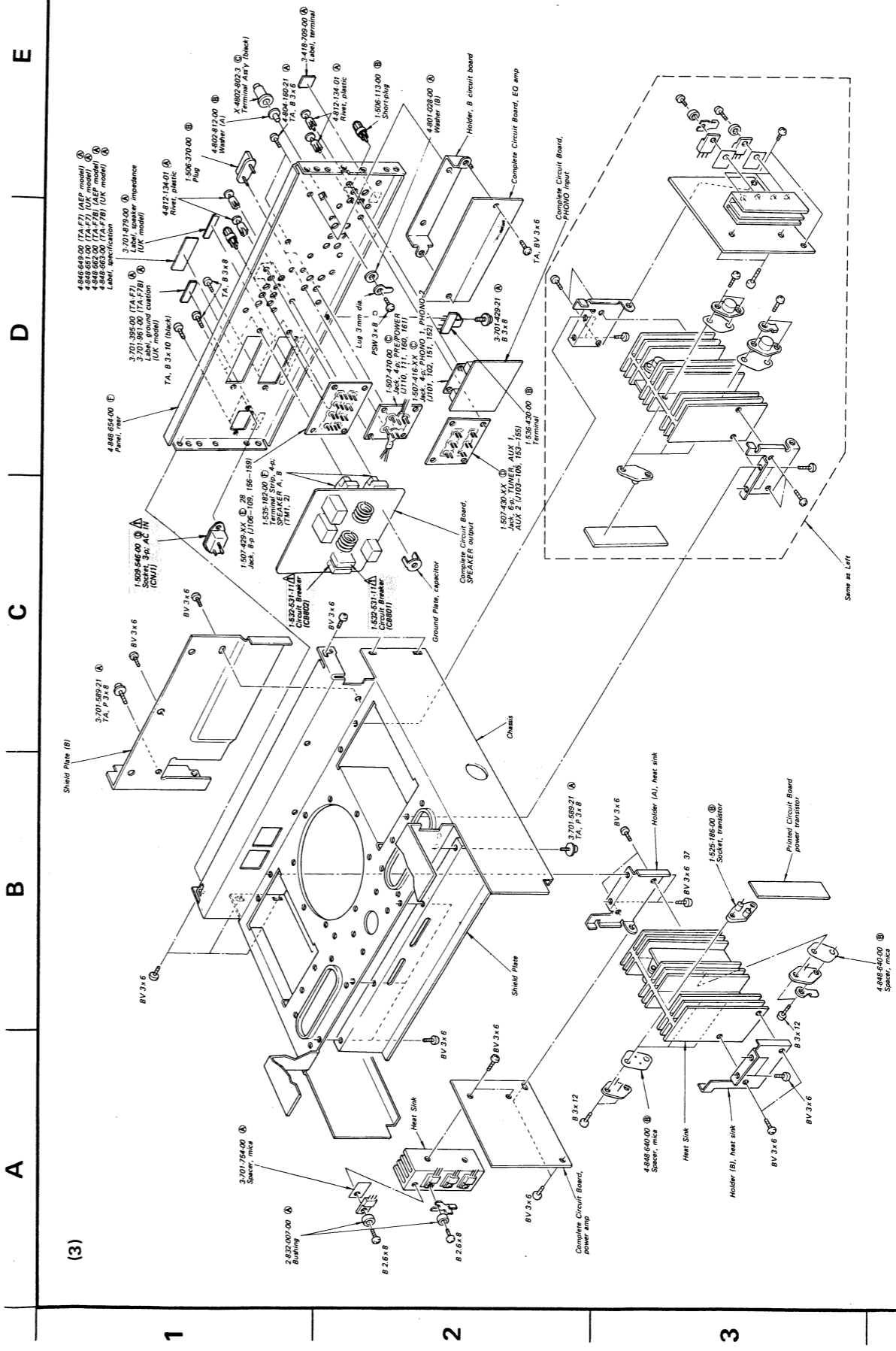

Note:

- Items with no part number and/or no description are not stocked because they are seldom required for routine service.
- All screws are Phillips (cross recess) type unless otherwise noted.
- (-) = slotted head

• Circled letters (A to Z) are applicable to European models only.

Note: The components identified by shading and Δ mark are critical for safety. Replace only with part number specified.

SECTION 6
ELECTRICAL PARTS LIST

• Circled letters (A to Z) are applicable to European models only.

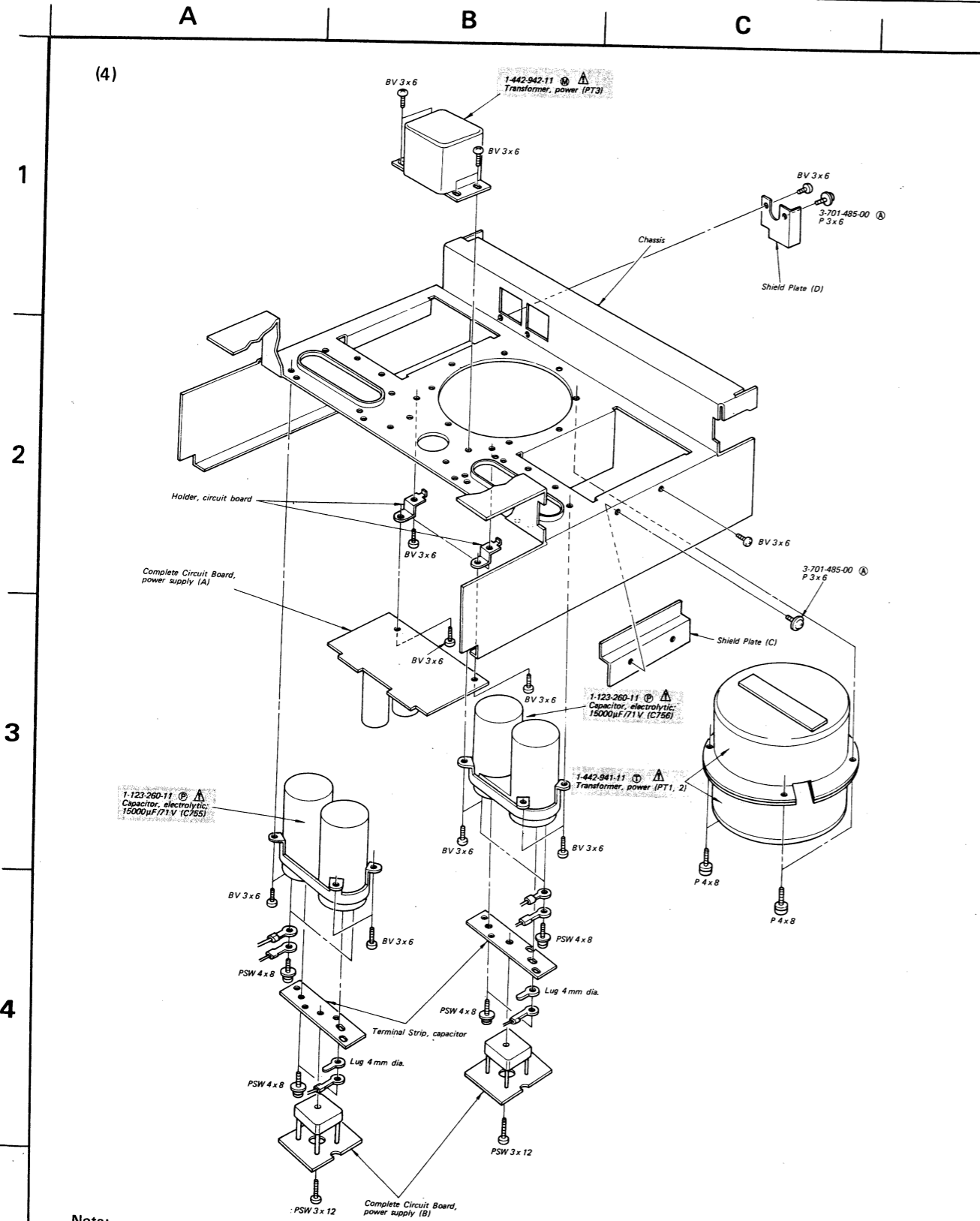

1
2
3
4
5

Ref. No.	Part No.	Description	Ref. No.	Part No.	Description
PRINTED CIRCUIT BOARD					
1-585-589-12	E	Power Amp	⇒ Q603,604 ⇒ Q653,654 Q605,655 Q606,656 Q607,657	B F C C	2SK30A-GR 2SK97 2SC1128 2SA639S
SEMICONDUCTORS					
Transistors					
Q101,151 Q102-104 Q152-154 ⇒ Q105,155 Q106,107 Q156,157	F C C	2SK97 2SC1128 2SK43-2 2SA639S	Q608,658 Q609,659 Q610,660 Q611,661 Q612,662	C C C C	2SA896 2SC1128 2SC1811 2SA678
Q108,158 Q109,159	C C	2SA896 2SC1811	Q613,663 Q614,664 Q615,665 Q616,666 Q617,667	B C C D	2SC634A 2SA678 2SC1124 2SA706
Q201,202 Q251,252 Q203,253 Q204,254 Q205,206 Q255,256 Q207,257	F C C C C C	2SK43-3A 2SC1128 2SA896 2SC1128 2SC1811	Q618,668 Q619,669 Q620,670 Q621,671	C C	2SC1173 2SA473
Q401,451	B	2SC1636	Q701 Q702 Q703 Q704 ⇒ Q705	B C B D B	2SC634A 2SA678 2SC634A 2SC1061 2SC634A
⇒ Q501,551 Q502,552 Q503,553 Q504,554 Q505	F C C C D	2SK43-3A 2SA896 2SC1811 2SC1128 2SC1061	⇒ Q706 Q707 Q708,709 Q710 ⇒ Q711	C B C E C	2SK42-2 2SC634A 2SA899 2SA671 2SK42-2
Q555 ⇒ Q506 Q556 Q507 ⇒ Q557	E B C C B	2SA671 2SC634A 2SA899 2SA899 2SC634A	Q801,851 Q802,803	B C	2SC634A 2SA678
⇒ Q508 Q558 ⇒ Q509,559	B C C	2SC634A 2SA899 2SK42-2	Q901-903 Q951-953 Q904-906 Q954-956	J K	2SK60 2SJ18
Q601,602 Q651,652	C	2SA678	D101,151	B	1S1555

- Note:**
- Items with no part number and/or no description are not stocked because they are seldom required for routine service.
 - All screws are Phillips (cross recess) type unless otherwise noted.
(-) = slotted head
 - Circled letters (A to Z) are applicable to European models only.

Note: The components identified by shading and mark are critical for safety. Replace only with part number specified.

• ⇒: Due to standardization, interchangeable replacements may be substituted for parts specified in the diagrams.

SECTION 6
ELECTRICAL PARTS LIST

• Circled letters (A to Z) are applicable to European models only.

• Circled letters (A to Z) are applicable to European models only.

Ref. No.	Part No.	Description	Ref. No.	Part No.	Description
PRINTED CIRCUIT BOARD					
	1-585-589-12	(E) Power Amp	⇒ Q603,604 ⇒ Q653,654	(B) 2SK30A-GR	
SEMICONDUCTORS					
Transistors					
Q101,151	(F) 2SK97		Q605,655	(F) 2SK97	
Q102-104, Q152-154	(C) 2SC1128		Q606,656	(C) 2SC1128	
⇒ Q105,155	(C) 2SK43-2		Q607,657	(C) 2SA639S	
Q106,107, Q156,157	(C) 2SA639S		Q608,658	(C) 2SA896	
Q108,158	(C) 2SA896		Q609,659	(C) 2SC1128	
Q109,159	(C) 2SC1811		Q610,660	(C) 2SC1128	
Q201,202, Q251,252	(F) 2SK43-3A		Q611,661	(C) 2SC1811	
Q203,253	(C) 2SC1128		Q612,662	(C) 2SA678	
Q204,254	(C) 2SA896		Q613,663	(B) 2SC634A	
Q205,206, Q255,256	(C) 2SC1128		Q614,664	(C) 2SA678	
Q207,257	(C) 2SC1811		Q615,665	(C) 2SC1124	
Q401,451	(B) 2SC1636		Q616,666	(D) 2SA706	
⇒ Q501,551	(F) 2SK43-3A		Q617,667		
Q502,552	(C) 2SA896		Q618,668, Q619,669	(C) 2SC1173	
Q503,553	(C) 2SC1811		Q620,670, Q621,671	(C) 2SA473	
Q504,554	(C) 2SC1128		Q701	(B) 2SC634A	
Q505	(D) 2SC1061		Q702	(C) 2SA678	
Q555	(E) 2SA671		Q703	(B) 2SC634A	
⇒ Q506	(B) 2SC634A		Q704	(D) 2SC1061	
Q556	(C) 2SA899		⇒ Q705	(B) 2SC634A	
Q507	(C) 2SA899		⇒ Q706	(C) 2SK42-2	
⇒ Q557	(B) 2SC634A		Q707	(B) 2SC634A	
⇒ Q508	(B) 2SC634A		Q708,709	(C) 2SA899	
Q558	(C) 2SA899		Q710	(E) 2SA671	
⇒ Q509,559	(C) 2SK42-2		⇒ Q711	(C) 2SK42-2	
Q601,602, Q651,652	(C) 2SA678		Q801,851	(B) 2SC634A	
			Q802,803	(C) 2SA678	
			Q901-903, Q951-953	(J) 2SK60	
			Q904-906, Q954-956	(K) 2SJ18	
				Diodes	
			D101,151	(B) 1S1555	

• ⇒: Due to standardization, interchangeable replacements may be substituted for parts specified in the diagrams.

Ref. No.	Part No.	Description	Ref. No.	Part No.	Description
⇒ D501,551	(B) EQB01-07		⇒ D601,651	(C) KB462S	
D602,652	(C) SV04S		D603-606, D653-656	(B) 1S1555	
D701-706	(B) 10E2		D707	(B) 1S1555	
⇒ D708	(B) 10E2		⇒ D709,710	(B) EQB01-11Z	
⇒ D711,712	(B) EQB01-07		⇒ D711,712	(B) EQB01-07	
D751,752	(F) S5VB20		D801,851, D802,852	(B) 1T22M	
THERMISTORS					
Th801,851	1-800-202-XX	(A) Thermistor, S-10K	PTh1,2	1-800-427-00	(B) Thermistor
COILS					
L401,451	1-407-879-00	(B) 33 mH, microinductor	L801,851	1-420-879-00	(B) Coil
TRANSFORMERS					
PT1,2	1-442-941-11	(T) Power	PT3	1-442-942-11	(M) Power
CAPACITORS					
All capacitors are in μ F and ceramic unless otherwise noted. 50WV or less are not indicated except for electrolytics. pF = μ μ F, elect = electrolytic					
C001,002	1-119-216-11	(B) 33 25V elect	C101,151	1-102-963-11	(A) 33p
C102,152	1-101-005-11	(A) 0.022	C103,153, C104,154	1-102-973-11	(A) 100p
C105,155	1-130-131-11	(B) 1600p 100V polyethylene	C106,156	1-130-132-11	(B) 5600p 100V polyethylene
C107,157	1-131-217-11	(B) 2.2 35V tantalum	C108,158	1-102-959-11	(A) 22p
C109,159	1-130-122-11	(B) 1000p 100V polyethylene	C110,160, C111,161	1-123-250-11	(B) 2.2 100V elect
C112,162	1-130-133-11	(B) 56000p 100V polyethylene	C201,251	1-102-971-11	(A) 82p
C202,252	1-102-824-11	(A) 470p	C203,253, C204,254	1-131-295-11	(C) 100 6.3V tantalum
C205,255	1-130-133-11	(B) 56000p 100V polyethylene	C208	1-108-227-12	(A) 0.001 mylar
C401,451	1-108-360-12	(A) 0.039 mylar	C402,452	1-108-364-12	(B) 0.18 mylar
C403,453	1-108-581-12	(B) 0.012 mylar	C404,454, C405,455	1-108-254-12	(B) 0.22 mylar
C501,551	1-102-115-11	(A) 560p	C502,552, C503,553	1-108-228-12	(A) 0.0015 mylar
C504,554, C505,555	1-108-237-12	(A) 0.0068 mylar	C506,556	1-108-360-12	(A) 0.039 mylar
C507,557	1-108-364-12	(B) 0.18	C508,558	1-102-125-11	(A) 4700p
C509,559, C510,560	1-131-239-11	(B) 6.8 35V tantalum	C511,561	1-130-083-11	(C) 1 100V polyethylene
C514,564	1-121-411-11	(B) 47 50V elect	C517,567	1-130-086-11	(B) 0.47 100V polyethylene
C601,651	1-101-005-11	(A) 0.022	C602,652	1-102-963-11	(A) 33p
C603,653	1-101-361-11	(A) 150p	C604,654, C605,655	1-102-934-11	(A) 1p

⇒: Due to standardization, interchangeable replacements may be substituted for parts specified in the diagrams.

Note: The components identified by shading and A mark are critical for safety. Replace only with part number specified.

Note: Circled letters (A to Z) are applicable to European models only.

Ref. No.	Part No.	Description
C606,656	1-101-001-11 (A) 1000p	
C607,657	1-102-973-11 (A) 100p	
C608,658	1-101-001-11 (A) 1000p	
C609,659	1-121-651-11 (A) 10 16V elect	
C610,660		
C611,661	1-108-244-12 (A) 0.033 mylar	
C701,702	1-123-261-11 (E) 2200 63V elect	
C703,704	1-130-086-11 (B) 0.47 100V polyethylene	
C705	1-123-183-11 (A) 10 50V elect	
C706	1-123-250-11 (B) 2.2 100V elect	
C707	1-121-726-11 (A) 0.47 50V elect	
C708	1-121-419-11 (B) 220 6.3V elect	
C712,717	1-121-421-11 (B) 220 16V elect	
C713,718	1-121-738-11 (B) 10 50V elect	
C751-754	1-130-084-11 (D) 2.2 100V polyethylene	
C755,756	1-123-260-11 (P) 15000 71V elect	
C801,851	1-102-824-11 (A) 470p	
C802,852	1-121-391-11 (A) 1 50V elect	
C803,853	1-108-355-12 (A) 0.0056 mylar	
C805	1-121-424-11 (B) 470 6.3V elect	
C806-808	1-121-726-11 (A) 0.47 50V elect	
C901,951	1-119-372-11 1 100V elect	
C902,952		

RESISTORS

All resistors are in ohms. Common 1/4W carbon resistors are omitted. Check schematic diagram for values.

R101,151	1-244-914-11 (A) 51k 1/2W
R102,152	1-244-873-11 (A) 1k 1/2W
R103,153	1-244-864-11 (A) 430 1/2W
R104,154	1-244-909-11 (A) 33k 1/2W
R105,155	1-244-865-11 (A) 470 1/2W
R107,157	1-244-873-11 (A) 1k 1/2W
R108,158	1-214-172-11 (B) 47k 1/4W metal oxide
R109,159	1-214-473-11 (B) 576k 1/2W metal oxide
R116,166	1-244-945-11 (A) 1M 1/2W
R117,167	1-244-909-11 (A) 33k 1/2W
R118,168	1-244-873-11 (A) 1k 1/2W

Note: The components identified by shading and A mark are critical for safety. Replace only with part number specified.

Ref. No.	Part No.	Description
R120,170	1-244-873-11 (A) 1k 1/2W	
R202,252	1-244-919-11 (A) 2k 1/2W	
R203,253	1-244-945-11 (A) 1M 1/2W	
R204,254	1-244-873-11 (A) 1k 1/2W	
R205,255	1-244-905-11 (A) 22k 1/2W	
R206,256		
R208,258	1-244-877-11 (A) 1.5k 1/2W	
R209,259	1-244-897-11 (A) 10k 1/2W	
R214,264	1-244-873-11 (A) 1k 1/2W	
R219	1-244-881-11 (A) 2.2k 1/2W	
R301,351	1-244-897-11 (A) 10k 1/2W	
R302,352		
R509,559	1-244-873-11 (A) 1k 1/2W	
R510,560	1-244-945-11 (A) 1M 1/2W	
R511,561	1-244-893-11 (A) 6.8k 1/2W	
R512,562	1-244-881-11 (A) 2.2k 1/2W	
R513,563	1-244-897-11 (A) 10k 1/2W	
R514,564	1-244-861-11 (A) 330 1/2W	
R520,570	1-244-897-11 (A) 10k 1/2W	
R521,571	1-244-856-11 (A) 200 1/2W	
R524,574	1-212-869-11 (A) 33 1/4W fusible	
R527,577	1-212-990-11 (A) 220 1/2W fusible	
R601,651	1-244-873-11 (A) 1k 1/2W	
R602,652	1-244-921-11 (A) 100k 1/2W	
R605,655	1-244-873-11 (A) 1k 1/2W	
R606,656		
R611,661	1-244-887-11 (A) 3.9k 1/2W	
R612,662	1-244-921-11 (A) 100k 1/2W	
R613,663	1-244-897-11 (A) 10k 1/2W	
R614,664		
R615,665	1-244-921-11 (A) 100k 1/2W	
R622,672	1-211-522-11 (A) 100 1/4W	
R624,674	1-211-530-11 (A) 220 1/4W	
R629,679	1-211-630-11 (A) 470 1/2W	
R630-633	1-217-158-11 (A) 0.47 5W metal oxide	
R680-683		
R634,684	1-217-481-11 (B) 10 1W fusible	
R708	1-211-516-11 (A) 56 1/4W	

Note: Circled letters (A to Z) are applicable to European models only.

Ref. No.	Part No.	Description
R711,717	1-211-409-11 (A) 10 1/8W	
R713,720	1-244-897-11 (A) 10k 1/2W	
R714,719	1-244-886-11 (A) 3.6k 1/2W	
R751,752	1-244-913-11 (A) 47k 1/2W	
R804,854	1-213-147-11 (A) 2.2k 1W metal oxide	
R806,856	1-244-865-11 (A) 470 1/2W	
R807,857		
R808,858	1-212-370-11 (A) 6.8 1W	
R812	1-206-666-11 (A) 1.2k 2W metal oxide	
R813,814	1-217-160-11 (A) 1 5W metal oxide	
R901,951	1-211-522-11 (A) 100 1/4W	
R902,952		
RT601,651	1-224-487-00 (B) 220 adjustable	
RT602,652	1-224-661-00 (B) 47k adjustable	
RT801,851	1-224-492-00 (B) 100k adjustable	
RV201,251	2-224-987-00 (H) 100k, variable; ATTENUATOR	
RV401,451	1-224-986-00 (E) 100k, variable; BALANCE	
RV402,452	1-224-988-00 (H) 50k, variable; TREBLE	
RV403,453	1-224-989-00 (H) 51k, variable; BASS	

SWITCHES

S1	1-552-089-00 (E) Lever Slide, FUNCTION (1)
S2	1-552-182-00 (F) Rotary Slide, FUNCTION (2)
S3,4	1-552-032-00 (D) Lever Slide, TAPE COPY, MONITOR
S5	1-552-087-00 (F) Rotary, MODE
S6	1-552-031-00 (C) Lever Slide, MUTING
S7-9	1-552-090-00 (H) Lever Slide, TURNOVER (BASS, TREBLE)/TONE
S10,11	1-552-085-00 (D) Lever Slide, LOW FILTER, HIGH FILTER
S12	1-552-086-00 (F) Rotary, SPEAKER
S13	1-552-141-00 (E) Pushbutton, POWER

JACKS

J001	1-507-454-00 (C) HEADPHONES
J101,151	1-507-416-XX (C) 4p, PHONO 1, PHONO 2
J102,152	
J103-105	1-507-430-XX (D) 6p, TUNER, AUX 1, AUX 2
J153-155	

Note: The components identified by shading and A mark are critical for safety. Replace only with part number specified.

Ref. No.	Part No.	Description
J106-109	1-507-429-XX (E) 8p, TAPE 1, TAPE 2 REC OUT 1, REC OUT 2	
J156-159		
J110,160		
J111,161	1-507-470-00 (C) 4p, PRE/POWER	
J501	1-507-453-00 (C) TAPE 2	
J502	1-507-454-00 (C) REC OUT 2	
CNJ	1-509-546-00 (D) 3p, socket; AC IN	
MISCELLANEOUS		
CB801,802	1-532-531-11 (C) Circuit Breaker, 2A	
CP701	1-102-355-11 (B) Encapsulated Component	
CP751,752		
F801	1-532-496-11 (C) Fuse 10A	
M801,851	1-520-291-00 (L) Meter, level	
RY001,002	1-515-277-00 (F) Relay	
RY801,802	1-515-257-00 (H) Relay (TA-F7)	
	1-515-293-00 (H) Relay (TA-F7B)	
RY803	1-515-278-00 (F) Relay	
TM1,2	1-535-182-00 (F) Terminal Strip, 4p; SPEAKER A, B	
	1-506-370-00 (B) Plug	
	1-525-186-00 (B) Socket, transistor	
	1-536-430-12 (B) Terminal Strip	

ACCESSORIES & PACKING MATERIALS

Part No.	Description
1-506-113-00	(B) Short Plug
1-534-819-12	(C) Cord, power (UK model)
3-701-020-00	(A) Bag, SS check sheet
3-701-622-00	(A) Bag, plastic (UK model)
3-770-394-11	(K) Manual, instruction
4-848-648-00	(B) Bag, protection
4-848-659-00	(H) Carton (TA-F7)
4-848-664-00	(H) Carton (TA-F7B)
4-848-660-00	(D) Frame
4-848-661-00	(C) Cushion, lower
4-848-658-00	(C) Cushion, upper

Ref. Desi
P
PV
PS
PE
PS
PS
R
K
Ri
B
T
F
Ri
BV

TA-F7/TA-F7B TA-F7/TA-F7B

Note: Circled letters (A to Z) are applicable to European models only.

HARDWARE NOMENCLATURE

Ref. No. Part No. Description

R711,717	Ⓐ1-211-409-11	Ⓐ 10 1/8W
R713,720	1-244-897-11	Ⓐ 10 k 1/2W
R714,719	1-244-886-11	Ⓐ 3.6 k 1/2W
R751,752	Ⓐ1-244-913-11	Ⓐ 47 k 1/2W

R804,854	Ⓐ1-213-147-11	Ⓐ 2.2 k 1W metal oxide
R806,856	Ⓐ1-244-865-11	Ⓐ 470 1/2W
R807,857	Ⓐ1-212-370-11	Ⓐ 6.8 1W
R812	Ⓐ1-206-666-11	Ⓐ 1.2 k 2W metal oxide
R813,814	Ⓐ1-217-160-11	Ⓐ 1 5W metal oxide

R901,951	Ⓐ1-211-522-11	Ⓐ 100 1/4W
R902,952		

RT601,651	1-224-487-00	Ⓑ 220 adjustable
RT602,652	1-224-661-00	Ⓑ 47 k adjustable

RT801,851	1-224-492-00	Ⓑ 100 k adjustable
-----------	--------------	--------------------

RV201,251	2-224-987-00	Ⓕ 100 k, variable; ATTENUATOR
-----------	--------------	-------------------------------

RV401,451	1-224-986-00	Ⓔ 100 k, variable; BALANCE
RV402,452	1-224-988-00	Ⓕ 50 k, variable; TREBLE
RV403,453	1-224-989-00	Ⓕ 51 k, variable; BASS

SWITCHES

S1	1-552-089-00	Ⓔ Lever Slide, FUNCTION (1)
S2	1-552-182-00	Ⓕ Rotary Slide, FUNCTION (2)
S3,4	1-552-032-00	Ⓖ Lever Slide, TAPE COPY, MONITOR
S5	1-552-087-00	Ⓕ Rotary, MODE
S6	1-552-031-00	Ⓔ Lever Slide, MUTING

S7-9	1-552-090-00	Ⓕ Lever Slide, TURNOVER (BASS, TREBLE)/TONE
------	--------------	---

S10,11	1-552-085-00	Ⓖ Lever Slide, LOW FILTER, HIGH FILTER
--------	--------------	--

S12	1-552-086-00	Ⓕ Rotary, SPEAKER
S13	Ⓐ1-552-141-00	Ⓔ Pushbutton, POWER

JACKS

J001	1-507-454-00	Ⓒ HEADPHONES
J101,151	1-507-416-XX	Ⓒ 4p, PHONO 1, PHONO 2
J102,152		
J103-105	1-507-430-XX	Ⓖ 6p, TUNER, AUX 1, AUX 2
J153-155		

Ref. No. Part No. Description

J106-109	1-507-429-XX	Ⓔ 8p, TAPE 1, TAPE 2
J156-159		
J110,160	1-507-470-00	Ⓒ 4p, PRE/POWER
J111,161		

J501	1-507-453-00	Ⓒ TAPE 2
J502	1-507-454-00	Ⓒ REC OUT 2

CNJ	Ⓐ1-509-546-00	Ⓖ 3p, socket; AC IN
-----	---------------	---------------------

MISCELLANEOUS

CB801,802	Ⓐ1-532-531-11	Ⓒ Circuit Breaker, 2A
CP701	Ⓐ1-102-355-11	Ⓑ Encapsulated Component
CP751,752		

F801	Ⓐ1-532-496-11	Ⓒ Fuse 10A
------	---------------	------------

M801,851	1-520-291-00	Ⓖ Meter, level
----------	--------------	----------------

RY001,002	1-515-277-00	Ⓕ Relay
RY801,802	1-515-257-00	Ⓕ Relay (TA-F7)
	1-515-293-00	Ⓕ Relay (TA-F7B)
RY803	1-515-278-00	Ⓕ Relay

TM1,2	1-535-182-00	Ⓕ Terminal Strip, 4p; SPEAKER A, B
-------	--------------	------------------------------------

1-506-370-00	Ⓑ Plug
1-525-186-00	Ⓑ Socket, transistor
1-536-430-12	Ⓑ Terminal Strip

ACCESSORIES & PACKING MATERIALS

Part No.	Description
1-506-113-00	Ⓑ Short Plug
1-534-819-12	Ⓒ Cord, power (UK model)
3-701-020-00	Ⓐ Bag, SS check sheet
3-701-622-00	Ⓐ Bag, plastic (UK model)
3-770-394-11	Ⓖ Manual, instruction
4-848-648-00	Ⓑ Bag, protection
4-848-659-00	Ⓕ Carton (TA-F7)
4-848-664-00	Ⓕ Carton (TA-F7B)
4-848-660-00	Ⓖ Frame
4-848-661-00	Ⓒ Cushion, lower
4-848-658-00	Ⓒ Cushion, upper

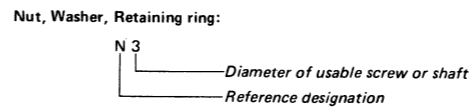
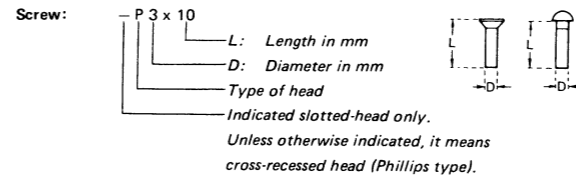

Reference Designation	Shape	Description	Remarks
SCREWS			
P		pan-head screw	binding-head (B) screw for replacement
PWH		pan-head screw with washer face	binding-head (B) screw and flat washer for replacement
PS PSP		pan-head screw with spring washer	binding-head (B) screw and spring washer for replacement
PSW PSPW		pan-head screw with spring and flat washers	binding-head (B) screw and spring and flat washers for replacement
R		round-head screw	binding-head (B) screw for replacement
K		flat-countersunk-head screw	
RK		oval-countersunk-head screw	
B		binding-head screw	
T		truss-head screw	binding-head (B) screw for replacement
F		flat-fillister-head screw	
RF		fillister-head screw	
BV		braizer-head screw	

Reference Designation	Shape	Description	Remarks
SELF-TAPPING SCREWS			
TA		self-tapping screw	ex: TA, P 3 x 10
PTP		pan-head self-tapping screw	binding-head self-tapping (TA, B) screw for replacement
PTPWH		pan-head self-tapping screw with washer face	binding-head self-tapping (TA, B) screw and flat washer for replacement
PTTWH		pan-head thread-rolling screw with washer face	binding-head (B) screw and flat washer for replacement
SET SCREWS			
SC		set screw	
SC		hexagon-socket set screw	ex: SC 2.6 x 4, hexagon socket
NUT			
N		nut	
WASHERS			
W		flat washer	
SW		spring washer	
LW		internal-tooth lock washer	ex: LW3, internal
LW		external-tooth lock washer	ex: LW3, external
RETAINING RINGS			
E		retaining ring	
G		grip-type retaining ring	

1/4 WATT CARBON RESISTORS Ⓐ

Note: Circled letter (A) is applicable to European model only.

Ω	Part No.	Ω	Part No.	Ω	Part No.	Ω	Part No.	Ω	Part No.	Ω	Part No.	Ω	Part No.
1.0	1-244-601-11	10	1-244-625-11	100	1-244-649-11	1.0k	1-244-673-11	10k	1-244-697-11	100k	1-244-721-11	1.0M	1-244-745-11
1.1	1-244-602-11	11	1-244-626-11	110	1-244-650-11	1.1k	1-244-674-11	11k	1-244-698-11	110k	1-244-722-11	1.1M	1-244-746-11
1.2	1-244-603-11	12	1-244-627-11	120	1-244-651-11	1.2k	1-244-675-11	12k	1-244-699-11	120k	1-244-723-11	1.2M	1-244-747-11
1.3	1-244-604-11	13	1-244-628-11	130	1-244-652-11	1.3k	1-244-676-11	13k	1-244-700-11	130k	1-244-724-11	1.3M	1-244-748-11
1.5	1-244-605-11	15	1-244-629-11	150	1-244-653-11	1.5k	1-244-677-11	15k	1-244-701-11	150k	1-244-725-11	1.5M	1-244-749-11
1.6	1-244-606-11	16	1-244-630-11	160	1-244-654-11	1.6k	1-244-678-11	16k	1-244-702-11	160k	1-244-726-11	1.6M	1-244-750-11
1.8	1-244-607-11	18	1-244-631-11	180	1-244-655-11	1.8k	1-244-679-11	18k	1-244-703-11	180k	1-244-727-11	1.8M	1-244-751-11
2.0	1-244-608-11	20	1-244-632-11	200	1-244-656-11	2.0k	1-244-680-11	20k	1-244-704-11	200k	1-244-728-11	2.0M	1-244-752-11
2.2	1-244-609-11	22	1-244-633-11	220	1-244-657-11	2.2k	1-244-681-11	22k	1-244-705-11	220k	1-244-729-11	2.2M	1-244-753-11
2.4	1-244-610-11	24	1-244-634-11	240	1-244-658-11	2.4k	1-244-682-11	24k	1-244-706-11	240k	1-244-730-11	2.4M	1-244-754-11
2.7	1-244-611-11	27	1-244-635-11	270	1-244-659-11	2.7k	1-244-683-11	27k	1-244-707-11	270k	1-244-731-11	2.7M	1-244-755-11
3.0	1-244-612-11	30	1-244-636-11	300	1-244-660-11	3.0k	1-244-684-11	30k	1-244-708-11	300k	1-244-732-11	3.0M	1-244-756-11
3.3	1-244-613-11	33	1-244-637-11	330	1-244-661-11	3.3k	1-244-685-11	33k	1-244-709-11	330k	1-244-733-11	3.3M	1-244-757-11
3.6	1-244-614-11	36	1-244-638-11	360	1-244-662-11	3.6k	1-244-686-11	36k	1-244-710-11	360k	1-244-734-11	3.6M	1-244-758-11
3.9	1-244-615-11	39	1-244-639-11	390	1-244-663-11	3.9k	1-244-687-11	39k	1-244-711-11	390k	1-244-735-11	3.9M	1-244-759-11
4.3	1-244-616-11	43	1-244-640-11	430	1-244-664-11	4.3k	1-244-688-11	43k	1-244-712-11	430k	1-244-736-11	4.3M	1-244-760-11
4.7	1-244-617-11	47	1-244-641-11	470	1-244-665-11	4.7k	1-244-689-11	47k	1-244-713-11	470k	1-244-737-11	4.7M	1-244-761-11
5.1	1-244-618-11	51	1-244-642-11	510	1-244-666-11	5.1k	1-244-690-11	51k	1-244-714-11	510k	1-244-738-11	5.1M	1-244-762-11
5.6	1-244-619-11	56	1-244-643-11	560	1-244-667-11	5.6k	1-244-691-11	56k	1-244-715-11	560k	1-244-739-11		
6.2	1-244-620-11	62	1-244-644-11	620	1-244-668-11	6.2k	1-244-692-11	62k	1-244-716-11	620k	1-244-740-11		
6.8	1-244-621-11	68	1-244-645-11	680	1-244-669-11	6.8k	1-244-693-11	68k	1-244-717-11	680k	1-244-741-11		
7.5	1-244-622-11	75	1-244-646-11	750	1-244-670-11	7.5k	1-244-694-11	75k	1-244-718-11	750k	1-244-742-11		
8.2	1-244-623-11	82	1-244-647-11	820	1-244-671-11	8.2k	1-244-695-11	82k	1-244-719-11	820k	1-244-743-11		
9.1	1-244-624-11	91	1-244-648-11	910	1-244-672-11	9.1k	1-244-696-11	91k	1-244-720-11	910k	1-244-744-11		

Sony Corporation

© 1978

- 32 -

Note: The components identified by shading and Ⓐ mark are critical for safety. Replace only with part number specified.